

AnTech[®]

"Water Control Technologies"

www.enelsa.com



2025

PRODUCT CATALOGUE



www.enelsa.com



INDEX

1-3	—	01	Introduction
4-39	—	02	Dosing Pumps
40-49	—	03	Control Devices
50-65	—	04	Salt Chlorine Generators and Systems
65-101	—	05	Systems
102-137	—	06	Sensors
138-153	—	07	Auxiliary Equipments
154-161	—	08	Mixers
162-167	—	09	Waters Meters
168-173	—	10	Blowers
174-193	—	11	Portable Devices and Test Kits
194-199	—	12	Spare Parts
200-206	—	13	Technical Documents

02 Dosing Pumps

Dosing pumps are used for the transfer of an identified liquid. This transfer is usually provided from one container to another container or process. Dosing pumps allow transfers to open containers, closed containers and pressure lines.

With its high-precision microcontroller control and solenoid technology, AnTech dosing pumps offer models that can provide dosing with a precision of less than 0.1 ml. The models are available which can provide dosing up to 25 liters per hour at a counter pressure of 5 bars for high dosing needs and up to 3.5 liters per hour at a counter pressure of 20 bars for high-pressure dosing needs.

For mechanical diaphragm dosing pumps, it offers a wide range of products which can provide dosing up to between 1.4-14 and 4.9-49 liters per hour at a counter pressure of 5 bars and up to between 5-50 and 15-150 liters per hour at a counter pressure of 7 bars.

Dosing Pumps

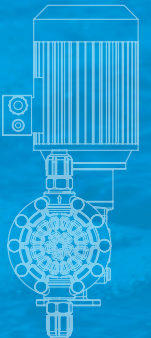
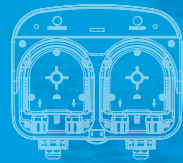
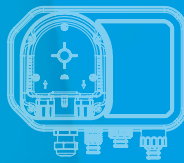
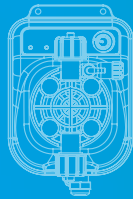
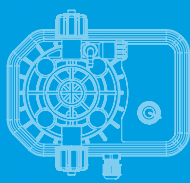
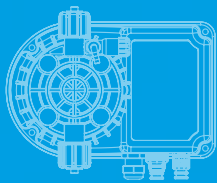

NOVA A

Analog, Fluid Level Controlled, 1/10 & 1/100 Precision Adjustable Dosing Pump











- Design with adjustable stroke rate with potentiometer on it
- Solenoid driven technology that can operate between 95-260 VAC and provides automatic adaptation to mains voltage
- Low energy consumption
- Thanks to its vertically mounted design and mounting foot on the chemical tank, alternative mounting, easy and flexible installation - use
- All-plastic IP65 body for high resistance to corrosive chemicals
- Electromagnet controlled by electronic circuit and long-life Teflon (PTFE) diaphragm
- Reduced maintenance thanks to zirconium ball design
- With PVDF injection and suction accessories
- Easily detachable power cord connection
- 2 inputs for liquid level control
- Easy adjustment button for 1/10 and 1/100 precision dosing levels

Stock Code	Model	Lt/H	Max. Counter Pressure/Bar	Package Sizes/cm W-L-H	Packed Weight/Kg
306110010302000	DP NOVA A 10L/10B VACFAT	10	10	23 x 32 x 23	4,10
306103520302000	DP NOVA A 3,5L/20B VACFAT	3,5	20	23 x 32 x 23	4,10
306125005302000	DP NOVA A 25L/5B VACFAT	25	5	23 x 32 x 23	4,10

The above products and the following spare parts are standard Viton O-Ring models. Please contact with us for EPDM and TEFLON options.

Spare Parts - Options

Stock Code	Stock Name	Description	Included in Package
 600110800131000	SUCTION SET 4X6 PS	Pvdf Suction Set With 4X6 mm Connection And Level Sensor With Viton Oring. For 3.5L/20B And 10L/10B Models	✓
 600110700323000	INJECTION SET 4X7 P	Pvdf Injection Set With 4X7 mm Connection With Viton Oring. For 3.5L/20B And 10L/10B Models.	✓
 600110500110000	HOSE SET V 4X7	Viton Hose Set For Suction,Injection And Air Bleeding Valve Connections.For 3,5L/20B And 10L/10B Models	✓
 600110800531000	SUCTION SET 9X12 PS	Pvdf Suction Set With 9X12 mm Connection And Level Sensor With Viton Oring.For 25L/5B Models	✓
 600110700343000	INJECTION SET 9X12 P	Pvdf Injection Set With 9X12 mm Connection With Viton Oring. For 25L/5B Models	✓
 600110500120000	HOSE SET V 9X12	Viton Hose Set For Suction,Injection And Air Bleeding Valve Connections.For 25L/5B Models	✓
 600110400700000	MOUNTING SET DP NOVA	Set Of Screws And Anchors For Wall Mounting. For All Models	✓
 500010079100010	BASE FIXING BRACKET DP	Dosing Pump Foot Mount Bracket For Mounting A Flat Surface. For All Models.	✓
 600110200100042	HEAD SET 40V AUTO	Viton Head set With Automatic Air Bleeding Valve For 3.5L/20B And 10L/10B Models (Optional)	✗

NOVA D

Digital, Fluid Level - Flow Controlled & Volumetric Dosing Pump













- LCD display and easy to use keys, rapid shortcut for air bleeding mode
- Solenoid driven technology that can operate between 95-260 VAC and provides automatic adaptation to mains voltage
- Less maintenance thanks to zirconium ball and long-lasting Teflon (PTFE) diaphragm
- Manual operation, Real-time operation,
- Operation with signal input and signal ratio with water meters and flow meters,
- 4-20 mA/ 20-4 mA/0-20 mA/ 20-0 mA-controlled operation with analog input
- Ability to operate with volumetric ppm operating system,
- Operating with periodic operating system, operating with trigger operating system,
- Capacity unit options (Lt/H - Stroke/Minute - Stroke/Hour - %)
- Chemical and water level sensor inputs and flow sensor inputs
- Capacity calibration, Operation limitation feature, Stroke feedback setting
- ModBus RTU (RS485) communication input, Alarm notification and alarm output,
- Password Protection, PT100 sensor input

Stock Code	Model	Lt/H	Max. Counter Pressure/Bar	Package Sizes/cm W-L-H	Packed Weight/Kg
306210010302000	DP NOVA D 10L/10B VACFAT	10	10	23 x 32 x 23	4,10
306203520302000	DP NOVA D 3,5L/20B VACFAT	3,5	20	23 x 32 x 23	4,10
306225005302000	DP NOVA D 25L/5B VACFAT	25	5	23 x 32 x 23	4,10

The above products and the following spare parts are standard Viton O-Ring models. Please contact with us for EPDM and TEFLON options.

Spare Parts - Options

Stock Code	Stock Name	Description	Included in Package
 600110800131000	SUCTION SET 4X6 P5	Pvdf Suction Set With 4X6 mm Connection And Level Sensor With Viton Oring. For 3.5L/20B And 10L/10B Models	✓
 600110700323000	INJECTION SET 4X7 P	Pvdf Injection Set With 4X7 mm Connection With Viton Oring. For 3.5L/20B And 10L/10B Models.	✓
 600110500110000	HOSE SET V 4X7	Viton Hose Set For Suction,Injection And Air Bleeding Valve Connections.For 3,5L/20B And 10L/10B Models	✓
 600110800531000	SUCTION SET 9X12 P5	Pvdf Suction Set With 9X12 mm Connection And Level Sensor With Viton Oring.For 25L/5B Models	✓
 600110700343000	INJECTION SET 9X12 P	Pvdf Injection Set With 9X12 mm Connection With Viton Oring. For 25L/5B Models	✓
 600110500120000	HOSE SET V 9X12	Viton Hose Set For Suction,Injection And Air Bleeding Valve Connections.For 25L/5B Models	✓
 600110400700000	MOUNTING SET DP NOVA	Set Of Screws And Anchors For Wall Mounting. For All Models	✓
 500010079100010	BASE FIXING BRACKET DP	Dosing Pump Foot Mount Bracket For Mounting A Flat Surface. For All Models	✓
 610103050000002	CABLE SET SIGNAL EXTERNAL DP NOVA	Plug-in Cable Set For Digital And Analog input-Output. For All Models	✗
 510011087010000	ELECTRONIC CARD MODUL DP NOVA COMM V1.0	Additional Module For Modbus Rtu (Rs485) Communication For All Models	✗
 600110200100042	HEAD SET 40V AUTO	Viton Head set With Automatic Air Bleeding Valve For 3.5L/20B And 10L/10B Models (Optional)	✗

NOVA DMPR

Digital, PH/ORP Measured & Liquid Level - Flow Controlled Dosing Pump





- LCD display and easy to use keys, rapid shortcut for Air bleeding mode, Password Protection
- Solenoid driven technology that can operate between 95-260 VAC and provides automatic adaptation to mains voltage
- Less maintenance thanks to zirconium ball and long-lasting Teflon (PTFE) diaphragm
- Proportional operation according to Ph or orp measurement, Sensor calibration
- Traceability of measurement values with 4-20 mA output
- Manual operation, Real-time operation,
- Operation with signal input and signal ratio with water meters and flow meters,
- 4-20 mA/ 20-4 mA/0-20 mA/ 20-0 mA-controlled operation with analog input,
- Ability to operate with volumetric ppm operating system,
- Operating with periodic operating system, operating with trigger operating system,
- Capacity unit options (Lt/H - Stroke/Minute - Stroke/Hour - %)
- Chemical and water level sensor inputs and flow sensor inputs, PT100 sensor input
- Capacity calibration, Operation limitation feature, Stroke feedback setting
- Alarm notification and alarm output, ModBus RTU (RS485) communication input

Stock Code	Model	Lt/H	Max. Counter Pressure/Bar	Package Sizes/cm W-L-H	Packed Weight/Kg
306310010302000	DP NOVA DMPR 10L/10B VACFAT	10	10	23 x 32 x 23	4,10
306303520302000	DP NOVA DMPR 3,5L/20B VACFAT	3,5	20	23 x 32 x 23	4,10
306325005302000	DP NOVA DMPR 25L/5B VACFAT	25	5	23 x 32 x 23	4,10

The above products and the following spare parts are standard Viton O-Ring models. Please contact with us for EPDM and TEFLON options.

* See page 17 for other auxiliary equipment.

Spare Parts - Options

Stock Code	Stock Name	Description	Included in Package
 600110800131000	SUCTION SET 4X6 P5	Pvdf Suction Set With 4X6 mm Connection And Level Sensor With Viton Oring. For 3.5L/20B And 10L/10B Models	✓
 600110700323000	INJECTION SET 4X7 P	Pvdf Injection Set With 4X7 mm Connection With Viton Oring. For 3.5L/20B And 10L/10B Models.	✓
 600110500110000	HOSE SET V 4X7	Viton Hose Set For Suction,Injection And Air Bleeding Valve Connections. For 3.5L/20B And 10L/10B Models	✓
 600110800531000	SUCTION SET 9X12 P5	Pvdf Suction Set With 9X12 mm Connection And Level Sensor With Viton Oring.For 25L/5B Models	✓
 600110700343000	INJECTION SET 9X12 P	Pvdf Injection Set With 9X12 mm Connection With Viton Oring. For 25L/5B Models	✓
 600110500120000	HOSE SET V 9X12	Viton Hose Set For Suction,Injection And Air Bleeding Valve Connections.For 25L/5B Models	✓
 600110400700000	MOUNTING SET DP NOVA	Set Of Screws And Anchors For Wall Mounting. For All Models	✓
 500010079100010	BASE FIXING BRACKET DP	Dosing Pump Foot Mount Bracket For Mounting A Flat Surface. For All Models.	✓
 610103050000002	CABLE SET SIGNAL EXTERNAL DP NOVA	Plug-in Cable Set For Digital And Analog input-Output. For All Models.	✗
 510011087010000	ELECTRONIC CARD MODUL DP NOVA COMM V1.0	Additional Module For Modbus Rtu (Rs485) Communication For All Models	✗
 600110200100042	HEAD SET 40V AUTO	Viton Head set With Automatic Air Bleeding Valve For 3.5L/20B And 10L/10B Models (Optional)	✗

NOVA DMIA

Digital, FCL Measured, Liquid Level-Flow Controlled & Volumetric Dosing Pump













- LCD display and easy to use keys, rapid shortcut for Air bleeding mode, Password Protection
- Solenoid driven technology that can operate between 95-260 VAC and provides automatic adaptation to mains voltage
- Less maintenance thanks to zirconium ball and long-lasting Teflon (PTFE) diaphragm
- Proportional operation according to the measurement of Amperometric Free Chlorine, Sensor calibration
- Free Chlorine, Chlorine Dioxide, Hydrogen Peroxide, Peracetic Acid measurements
- Traceability of measurement values with 4-20 mA output
- Manual-proportional operation, Real-time operation,
- Operation with signal input and signal ratio with water meters and flow meters,
- 4-20 mA/ 20-4 mA/0-20 mA/ 20-0 mA-controlled operation with analog input,
- Ability to operate with volumetric ppm operating system,
- Operating with periodic operating system, operating with trigger operating system,
- Capacity unit options (Lt/H - Stroke/Minute - Stroke/Hour - %)
- Chemical and water level sensor inputs and flow sensor inputs, PT100 sensor input
- Capacity calibration, Operation limitation feature, Stroke feedback setting
- Alarm notification and alarm output, ModBus RTU (RS485) communication input

Stock Code	Model	Lt/H	Max. Counter Pressure/Bar	Package Sizes/cm W-L-H	Packed Weight/Kg
306410010302000	DP NOVA DMIA 10L/10B VACFAT	10	10	23 x 32 x 23	4,10
306403520302000	DP NOVA DMIA 3,5L/20B VACFAT	3,5	20	23 x 32 x 23	4,10
306425005302000	DP NOVA DMIA 25L/5B VACFAT	25	5	23 x 32 x 23	4,10

The above products and the following spare parts are standard Viton O-Ring models. Please contact with us for EPDM and TEFLON options.

*. See page 10 for other auxiliary equipment.

Spare Parts - Options

Stock Code	Stock Name	Description	Included in Package
 600110800131000	SUCTION SET 4X6 PS	Pvdf Suction Set With 4X6 mm Connection And Level Sensor With Viton Oring. For 3.5L/20B And 10L/10B Models	✓
 600110700323000	INJECTION SET 4X7 P	Pvdf Injection Set With 4X7 mm Connection With Viton Oring. For 3.5L/20B And 10L/10B Models.	✓
 600110500110000	HOSE SET V 4X7	Viton Hose Set For Suction,Injection And Air Bleeding Valve Connections. For 3.5L/20B And 10L/10B Models	✓
 600110800531000	SUCTION SET 9X12 PS	Pvdf Suction Set With 9X12 mm Connection And Level Sensor With Viton Oring.For 25L/5B Models	✓
 600110700343000	INJECTION SET 9X12 P	Pvdf Injection Set With 9X12 mm Connection With Viton Oring. For 25L/5B Models	✓
 600110500120000	HOSE SET V 9X12	Viton Hose Set For Suction,Injection And Air Bleeding Valve Connections.For 25L/5B Models	✓
 600110400700000	MOUNTING SET DP NOVA	Set Of Screws And Anchors For Wall Mounting. For All Models	✓
 500010079100010	BASE FIXING BRACKET DP	Dosing Pump Foot Mount Bracket For Mounting A Flat Surface. For All Models.	✓
 610103050000002	CABLE SET SIGNAL EXTERNAL DP NOVA	Plug-in Cable Set For Digital And Analog input-Output. For All Models.	✗
 510011087010000	ELECTRONIC CARD MODUL DP NOVA COMM V1.0	Additional Module For Modbus Rtu (Rs485) Communication For All Models	✗
 600110200100042	HEAD SET 40V AUTO	Viton Head set With Automatic Air Bleeding Valve For 3.5L/20B And 10L/10B Models (Optional)	✗

AUXILIARY EQUIPMENT FOR NOVA SERIES

Stock Code	Model	Picture and Description
70442100000014	STN ELEKTRODE FCL/O 5 PPM SELECTIVE	 0-5 Ppm Selective Free Chlorine Sensor
70442100000013	STN ELEKTRODE FCL/O 2 PPM SELECTIVE	 0-2 Ppm Selective Free Chlorine Sensor
70442100000016	STN ELECTRODE CLO2/O 10 PPM SELECTIVE	 0-10 Ppm Selective Chlorine Dioxide Sensor
70442100000018	STN ELECTRODE H2O2/O 500 PPM SELECTIVE	 0-500 Ppm Selective Hydrogen Peroxide Sensor.
600510010111000	AMPEROMETRIC FREE CHLORINE CELL	 0-10 Ppm Amperometric Free Chlorine Electrode (Cu-Pt)
600112521000250	ELECTRODE HOUSING 2-25MM	 Flow Housing With Selective Electrode input.
600110400500010	MOUNTING SET OF ELECTROD HOUSING 2	 Connection Parts For Selective Electrode Input Housing.
600112510030000	ELECTRODE HOUSING SET 15L	 Housing With Selective Electrode input. With Dirt Trap Pre Filter-Ed And Sampling Valve.
600110400100010	MOUNTING SET FOR SYSTEM 2	 Connection Parts For Housing With Selective Electrode Input, Dirt Trap Pre Filter-Ed And Sampling Valve
410250010000000	DP PULSE CHECKER 0,6 MT	 Auxiliary Equipment Sensing Chemical Flow in The Discharge Line Of The Dosing Pump. For All Nova Digital Models

The sensors and holders in the above table are valid for the Nova DMIA series.

For Nova DMPR, probe holder sets on page 17 can be used.

Contact with us for more sensor and holder selections specific to different processes.

NOVA SERIES PUMP SPECIFICATIONS

Model	Max./Lt	Max./P	Stroke/dk	ml /Stroke	Suction Connection	Injection Connection	Supply Voltage	Watt	Product Weight	Body	Max. Temp.
	Lt / h	Bar	stroke	ml	mm	mm	Volt	W	kg	IP	°C
A	10L/10B	10	10	300	0,556	4x6	4x7	25			
		13	8		0,722						
		15	5		0,833						
		20	2		1,111						
D	3,5L/20B	3,5	20	150	0,389	4x6	4x7	15	2,9	65	For Ambient: 0-45 Chemical: 0-40
		4	16		0,444						
		5	10		0,556						
DMPR		8,5	2		0,944						
DMiA	25L/5B	25	5	300	1,389	9x12	9x12	27			
		30	3		1,667						
		40	1		2,222						
		55	0,1		3,056						

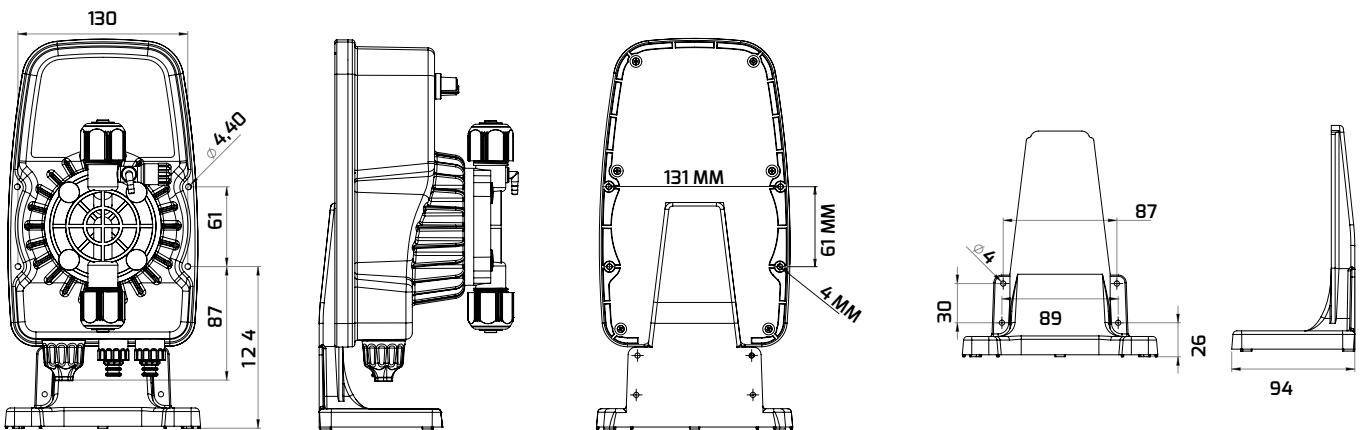

DP NOVA **A**

10L/10B

VACFAT

Code	Description
A	Analog, Fluid Level Controlled, 1/10 & 1/100 Precision Adjustable Dosing Pump
D	Digital, Fluid Level - Flow Controlled & Volumetric Dosing Pump
DMPR	Digital, PH/ORP Measured & Liquid Level - Flow Controlled Dosing Pump
DMiA	Digital, Free Chlorine Measurement, Liquid Level-Flow Control & Volumetric Dosing Pump

Code	Description
10L/10B	*It can dose maximum 10 liters against to maximum 10 bar counter pressure.
3,5L/20B	*It can dose maximum 3,5 liters against to maximum 20 bar counter pressure.
25L/5B	*It can dose maximum 25 liters against to maximum 5 bar counter pressure.

Code	Pump Head	Suction Injection Set	O-Rings	Injection Hose	Suction-Air Bleed Hose	Bleeding Output
V	PVDF	PVDF	Viton	PE	PVC	Manual
E	PVDF	PVDF	EPDM	PE	PVC	Manual
O-V	PVDF	PVDF	Viton	PE	PVC	*Automatic

Applies to 10L/10B and 3.5L/20B capacity models.

02 Electromagnetic Dosing Pumps

Lara Series

LARA A

Analog, Dosing Pump with on-off button









- Design with adjustable stroke rate with potentiometer on it
- On/Off Button
- Thanks to vertical-mounted design easy and flexible installation and operation
- PVDF head set with high resistance to corrosive chemicals and all IP65 body
- Electromagnet controlled by electronic circuit and long-life Teflon (PTFE) diaphragm
- Reduced maintenance thanks to zirconium ball design
- With injection and suction accessories

Stock Code	Model	Lt/H	Max. Counter Pressure/Bar	Package Sizes/cm W-L-H	Packed Weight/Kg
301102010101000	DP LARA A 2L/10B V220FAT	2	10	23 x 28 x 21	2,95
301105007101000	DP LARA A 5L/7B V220FAT	5	7	23 x 28 x 21	2,95
301110005101000	DP LARA A 10L/5B V220FAT	10	5	23 x 28 x 21	2,95
301102020101000	DP LARA A 2L/20B V220FAT	2	20	23 x 28 x 21	2,95

The above products and the following spare parts are standard Viton O-Ring models. Please contact with us for EPDM and TEFLON options.

Spare Parts - Options

Stock Code	Stock Name	Description	Included in Package
 600110800110000	SUCTION SET 4X6 V	Pp Suction Set With 4X6 mm Connection With Viton Oring. For All Models	✓
 600110700311000	INJECTION SET 4X6 V	Pp Injection Set With 4X6 mm Connection With Viton Oring. For 2L/10B - 5L/7B And 10L/5B Models.	✓
 600110500100000	HOSE SET V	Viton Hose Set For Suction,Injection And Air Bleeding Valve Connections.For 2L/10B - 5L/7B And 10L/5B Models	✓
 600110700321000	INJECTION SET 4X7 V	Pp Injection Set With 4X7 mm Connection With Viton Oring For 2L/20B Models.	✓
 600110500110000	HOSE SET V 4X7	Viton Hose Set For Suction,Injection And Air Bleeding Valve Connections.For 2L/20B Models.	✓
 600511010120100	YP CHECK VALVE SET 4050 VITON	Up and Down Viton Checkvalve sets for Head Sets 40 and 50	✓
 600110200100042	HEAD SET 40V AUTO	Viton Head set With Automatic Air Bleeding Valve For 2L/20B Model	✗

*: For models with PVDF kits. Indicate during your order

LARA APS

Analog, Fluid Level Controlled & 1/10 Adjustable Dosing Pump









- Design with adjustable stroke rate with potentiometer on it
- Fluid level control
- 1/10 adjustment button
- Thanks to vertical-mounted design easy and flexible installation and operation
- All-plastic body for high resistance to corrosive chemicals
- Electromagnet controlled by electronic circuit and long-life Teflon (PTFE) diaphragm
- Reduced maintenance thanks to zirconium ball design
- With injection and suction accessories

Stock Code	Model	Lt/H	Max. Counter Pressure/Bar	Package Sizes/cm W-L-H	Packed Weight/Kg
301302010101000	DP LARA APS 2L/10B V220FAT	2	10	23 x 28 x 21	3,00
301305007101000	DP LARA APS 5L/7B V220FAT	5	7	23 x 28 x 21	3,00
301310005101000	DP LARA APS 10L/5B V220FAT	10	5	23 x 28 x 21	3,00
301302020101000	DP LARA APS 2L/20B V220FAT	2	20	23 x 28 x 21	3,00

The above products and the following spare parts are standard Viton O-Ring models. Please contact with us for EPDM and TEFLON options.

Spare Parts - Options

Stock Code	Stock Name	Description	Included in Package
 600110800111000	SUCTION SET 4X6 V5	Pp Suction Set With 4X6 mm Connection And Level Sensor -With Viton Oring. For All Models.	✓
 600110700311000	INJECTION SET 4X6 V	Pp Injection Set With 4X6 mm Connection With Viton Oring. For 2L/10B - 5L/7B And 10L/5B Models.	✓
 600110500100000	HOSE SET V	Viton Hose Set For Suction,Injection And Air Bleeding Valve Connections.For 2L/10B - 5L/7B And 10L/5B Models	✓
 600110700321000	INJECTION SET 4X7 V	Pp Injection Set With 4X7 mm Connection With Viton Oring For 2L/20B Models.	✓
 600110500110000	HOSE SET V 4X7	Viton Hose Set For Suction,Injection And Air Bleeding Valve Connections.For 2L/20B Models.	✓
 600511010120100	YP CHECK VALVE SET 4050 VITON	Up and Down Viton Checkvalve sets for Head Sets 40 and 50	✓
 600110200100042	HEAD SET 40V AUTO	Viton Head set With Automatic Air Bleeding Valve For 2L/20B Models. (Optional)	✗

*: For models with PVDF kits. Indicate during your order

02 Electromagnetic Dosing Pumps

Lara Series

LARA DS

Digital, Timed, Liquid Level - Flow Controlled Dosing Pump









- Precise dosing with digital display and Micro controller technology
- Timed operation mode
- User password parameter
- Easy menu access thanks to button technology
- 2 BNC inputs that can be set to fluid level control or flow control
- Thanks to vertical-mounted design easy and flexible installation and operation
- All-plastic body for high resistance to corrosive chemicals
- Electromagnet controlled by electronic circuit and long-life Teflon (PTFE) diaphragm
- Reduced maintenance thanks to zirconium ball design
- With PP injection and suction accessories with liquid level sensor

Stock Code	Model	Lt/H	Max. Counter Pressure/Bar	Package Sizes/cm W-L-H	Packed Weight/Kg
301402010101000	DP LARA DS 2L/10B V220FAT	2	10	23 x 28 x 21	3,10
301405007101000	DP LARA DS 5L/7B V220FAT	5	7	23 x 28 x 21	3,10
301410005101000	DP LARA DS 10L/5B V220FAT	10	5	23 x 28 x 21	3,10
301402020101000	DP LARA DS 2L/20B V220FAT	2	20	23 x 28 x 21	3,10

The above products and the following spare parts are standard Viton O-Ring models. Please contact with us for EPDM and TEFLON options.

Spare Parts - Options

Stock Code	Stock Name	Description	Included in Package
 600110800111000	SUCTION SET 4X6 V5	Pp Suction Set With 4X6 mm Connection And Level Sensor -With Viton Oring. For All Models.	✓
 600110700311000	INJECTION SET 4X6 V	Pp Injection Set With 4X6 mm Connection With Viton Oring. For 2L/10B - 5L/7B And 10L/5B Models.	✓
 600110500100000	HOSE SET V	Viton Hose Set For Suction,Injection And Air Bleeding Valve Connections.For 2L/10B - 5L/7B And 10L/5B Models	✓
 600110700321000	INJECTION SET 4X7 V	Pp Injection Set With 4X7 mm Connection With Viton Oring For 2L/20B Models.	✓
 600110500110000	HOSE SET V 4X7	Viton Hose Set For Suction,Injection And Air Bleeding Valve Connections.For 2L/20B Models	✓
 600511010120100	YP CHECK VALVE SET 4050 VITON	Up and Down Viton Checkvalve sets for Head Sets 40 and 50	✓
 600110200100042	HEAD SET 40V AUTO	Viton Head set With Automatic Air Bleeding Valve For 2L/20B Models (Optional)	✗

*: For models with PVDF kits. Indicate during your order

LARA DMS

Digital, Volumetric, Timed, Liquid Level - Flow Controlled Dosing Pump











- Precise dosing with digital display and Micro controller technology
- Timed operation mode
- User password parameter
- Volumetric proportional control when connected to water meter
- 4-20 mA analog input, liquid level control alarm relay
- Thanks to vertical-mounted design easy and flexible installation and operation
- All-plastic body for high resistance to corrosive chemicals
- Electromagnet controlled by electronic circuit and long-life Teflon (PTFE) diaphragm
- Reduced maintenance thanks to zirconium ball design
- With PP injection and suction accessories with liquid level sensor

Stock Code	Model	Lt/H	Max. Counter Pressure/Bar	Package Sizes/cm W-L-H	Packed Weight/Kg
301602010101000	DP LARA DMS 2L/10B V220FAT	2	10	23 x 28 x 21	3,15
301605007101000	DP LARA DMS 5L/7B V220FAT	5	7	23 x 28 x 21	3,15
301610005101000	DP LARA DMS 10L/5B V220FAT	10	5	23 x 28 x 21	3,15
301602020101000	DP LARA DMS 2L/20B V220FAT	2	20	23 x 28 x 21	3,15

The above products and the following spare parts are standard Viton O-Ring models. Please contact with us for EPDM and TEFLON options.

Spare Parts - Options

Stock Code	Stock Name	Description	Included in Package
 600110800111000	SUCTION SET 4X6 V5	Pp Suction Set With 4X6 mm Connection And Level Sensor -With Viton Oring. For All Models.	✓
 600110700311000	INJECTION SET 4X6 V	Pp Injection Set With 4X6 mm Connection With Viton Oring. For 2L/10B - 5L/7B And 10L/5B Models.	✓
 600110500100000	HOSE SET V	Viton Hose Set For Suction,Injection And Air Bleeding Valve Connections.For 2L/10B - 5L/7B And 10L/5B Models	✓
 600110700321000	INJECTION SET 4X7 V	Pp Injection Set With 4X7 mm Connection With Viton Orign For 2L/20B Models.	✓
 600110500110000	HOSE SET V 4X7	Viton Hose Set For Suction,Injection And Air Bleeding Valve Connections.For 2L/20B Models	✓
 600511010120100	YP CHECK VALVE SET 4050 VITON	Up and Down Viton Checkvalve sets for Head Sets 40 and 50	✓
 610103050000001	CABLE SET SIGNAL EXTERNAL DP LARA	Cable Set With Mic Connection For Signal inputs And Alarm Output.	✓
 600110200100042	HEAD SET 40V AUTO	Viton Head set With Automatic Air Bleeding Valve For 2L/20B Models (Optional)	✗

∴: For models with PVDF kits. Indicate during your order

LARA PR

Digital, pH/ORP, Volumetric, Timed, Liquid Level-Flow Controlled Dosing Pump











- Precise dosing with digital display and Micro controller technology
- Timed operation mode
- User password parameter
- Redox or PH measurement with standard combined electrodes
- Fully digital automatic calibration using buffer liquid
- To be able to enter measurement value definition time at opening (0 - 60 min.)
- Volumetric proportional dosing when connected to the water meter or flow meters
- 4-20 mA analog input, liquid level control alarm relay
- Fluid level control,
- Thanks to vertical-mounted design easy and flexible installation and operation
- All-plastic body for high resistance to corrosive chemicals
- Electromagnet controlled by electronic circuit and long-life Teflon (PTFE) diaphragm
- Reduced maintenance thanks to zirconium ball design
- With PP injection and suction accessories with liquid level sensor

Stock Code	Model	Lt/H	Max. Counter Pressure/Bar	Package Sizes/cm W-L-H	Packed Weight/Kg
301002010101000	DP LARA PR 2L/10B V220FAT	2	10	23 x 28 x 21	3,60
301005007101000	DP LARA PR 5L/7B V220FAT	5	7	23 x 28 x 21	3,60
301010005101000	DP LARA PR 10L/5B V220FAT	10	5	23 x 28 x 21	3,60
301002020101000	DP LARA PR 2L/20B V220FAT	2	20	23 x 28 x 21	3,60

The above products and the following spare parts are standard Viton O-Ring models. Please contact with us for EPDM and TEFLON options. You can make chose the accessory from the probe holder table on page 17

Spare Parts - Options





Stock Code	Stock Name	Description	Included in Package
 600110800111000	SUCTION SET 4X6 VS	Pp Suction Set With 4X6 mm Connection And Level Sensor -With Viton Oring. For All Models.	✓
 600110700311000	INJECTION SET 4X6 V	Pp Injection Set With 4X6 mm Connection With Viton Oring. For 2L/10B - 5L/7B And 10L/5B Models.	✓
 600110500100000	HOSE SET V	Viton Hose Set For Suction,Injection And Air Bleeding Valve Connections.For 2L/10B - 5L/7B And 10L/5B Models	✓
 600110700321000	INJECTION SET 4X7 V	Pp Injection Set With 4X7 mm Connection With Viton Orign For 2L/20B Models.	✓
 600110500110000	HOSE SET V 4X7	Viton Hose Set For Suction,Injection And Air Bleeding Valve Connections.For 2L/20B Models	✓
 600511010120100	YP CHECK VALVE SET 4050 VITON	Up and Down Viton Checkvalve sets for Head Sets 40 and 50	✓
 610103050000001	CABLE SET SIGNAL EXTERNAL DP LARA	Cable Set With Mic Connection For Signal inputs And Alarm Output.	✗
 600110200100042	HEAD SET 40V AUTO	Viton Head set With Automatic Air Bleeding Valve For 2L/20B Models (Optional)	✗

*: For models with PVDF kits. Indicate during your order

LARA PR PROBE HOLDER SETS

Stock Code	Model	Description
410150011100001	PROBE HOLDER SET P 1 S	Electrode Ph 6M Sensor Xs + Submersible Probe Holder +Calibration Solutions Ph
410150011200001	PROBE HOLDER SET P 2 S	Electrode Ph 1M Sensor Xs + Electrode Housing 1 Filtered +CONNECTION KIT FLOW CELL + Calibration Solutions Ph
410150011300001	PROBE HOLDER SET P 3 S	Electrode Ph 6M Sensor Xs + Electrode Fixing Gland 1/2 + Calibration Solutions Ph
410150011400001	PROBE HOLDER SET P 4 S	Electrode Ph 6M Sensor Xs + Probe Holder Hose Type + Calibration Solutions Ph
410150012100001	PROBE HOLDER SET R 1 S	Electrode Orp 6M Sensor Xs + Submersible Probe Holder + Calibration Solutions Orp
410150012200001	PROBE HOLDER SET R 2 S	Electrode Orp 1M Sensor Xs + Electrode Housing 1 Filtered + Electrode Cell Set+ Calibration Solutions
410150012300001	PROBE HOLDER SET R 3 S	Electrode Orp 6M Sensor Xs + Electrode Fixing Gland 1/2 + Calibration Solutions Orp
410150012400001	PROBE HOLDER SET R 4 S	Electrode Orp 6M Sensor Xs + Probe Holder Hose Type + Calibration Solutions Orp
410150021100001	PROBE HOLDER SET P 1 E	Electrode Ph 6M E + Submersible Probe Holder + Calibration Solutions Ph
410150021200001	PROBE HOLDER SET P 2 E	Electrode Ph 1M E + Electrode Housing 1 Filtered + Electrode Cell Mounting Calibration Solutions Ph
410150021300001	PROBE HOLDER SET P 3 E	Electrode Ph 6M E + Electrode Fixing Gland 1/2 + Calibration Solutions Ph
410150021400001	PROBE HOLDER SET P 4 E	Electrode Ph 6M E + Probe Holder Hose Type + Calibration Solutions Ph
410150022100001	PROBE HOLDER SET R 1 E	Electrode Orp 6M E + Submersible Probe Holder + Calibration Solutions Orp
410150022200001	PROBE HOLDER SET R 2 E	Electrode Orp 1M E + Electrode Housing 1 Filtered + Electrode Cell Mounting Calibration Solutions Orp
410150022300001	PROBE HOLDER SET R 3 E	Electrode Orp 6M E + Electrode Fixing Gland 1/2 + Calibration Solutions Orp
410150022400001	PROBE HOLDER SET R 4 E	Electrode Orp 6M E + Probe Holder Hose Type + Calibration Solutions Orp

Electrode Holders

	<p>Stock Code : 410030010000000 Stock Name : SUBMERSIBLE PROBE HOLDER</p>		<p>Stock Code : 410190021100001 Stock Name : ELECTRODE FIXING GLAND 1/212MM PP</p>
	<p>Stock Code : 600112511010120 Stock Name : ELECTRODE HOUSING 1 FILTERED</p>		<p>Stock Code : 410030020000000 Stock Name : PROBE HOLDER PIPE TYPE</p>

LARA SERIES SPECIFICATIONS

Model	Max./Lt	Max./P	Stroke/dk	ml /Stroke	Suction Connection	Injection Connection	Supply Voltage	Watt	Product Weight	Body	Max. Temp.
	Lt / h	Bar	stroke	ml	mm	mm	Volt	W	kg	IP	°C
A	2L/10B	2	10	120	0,278	4x6	230V AC 50 Hz	17	2.2	65	For Ambient: 0-45 For Chemical: 0-40
APS	5L/7B	5	7	120	0,694	4x6					
DS											
DMS	10L/5B	10	5	150	1,111	4x6					
PR	2L/20B	2	20	120	0,278	4x6					

Flow-pressure graphs of Lara series dosing pumps can be found on page 197.

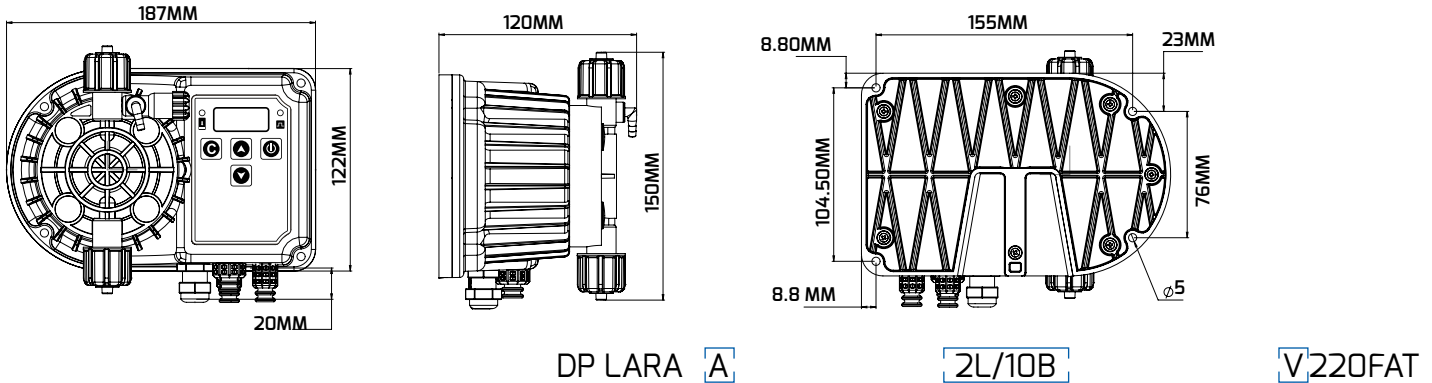

Code	Description
A	Analog, On/Off Button Dosing Pump
APS	Analog, Fluid Level Controlled & 1/10 Adjustable Dosing Pump
DS	Digital, Timed, Liquid Level - Flow Controlled Dosing Pump
DMS	Digital, Volumetric, Timed, Liquid Level - Flow Controlled Dosing Pump
PR	Digital, pH/ORP, Volumetric, Timed, Liquid Level - Flow Controlled Dosing Pump

Code	Description
2L/10B	It can dose maximum 2 liters against to maximum 10 bar counter pressure.
5L/7B	It can dose maximum 5 liters against to maximum 7 bar counter pressure.
10L/5B	It can dose maximum 10 liters against to maximum 5 bar counter pressure.
2L/20B	It can dose maximum 2 liters against to maximum 20 bar counter pressure.

Code	Pump Head	Suction-Injection Set	O-Rings	Injection Hose	Suction-Air Bleed Hose	Bleed Outlet
V	PVDF	PP	Viton	PE	PVC	Manual
E	PVDF	PP	EPDM	PE	PVC	Manual
P	PVDF	PVDF	Viton	PE	PE	Manual
EP	PVDF	PVDF	EPDM	PE	PE	Manual
O-V	PVDF	PP	Viton	PE	PVC	*Automatic
O-P	PVDF	PVDF	Viton	PE	PE	*Automatic

* Applies to 2L/20B capacity models.

LARA SERIAL SAMPLE APPLICATIONS

Sample Application 1

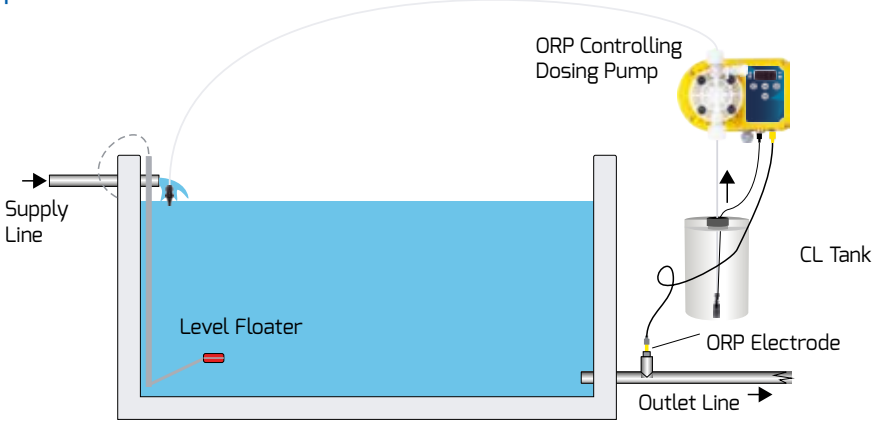

Sample Application 2

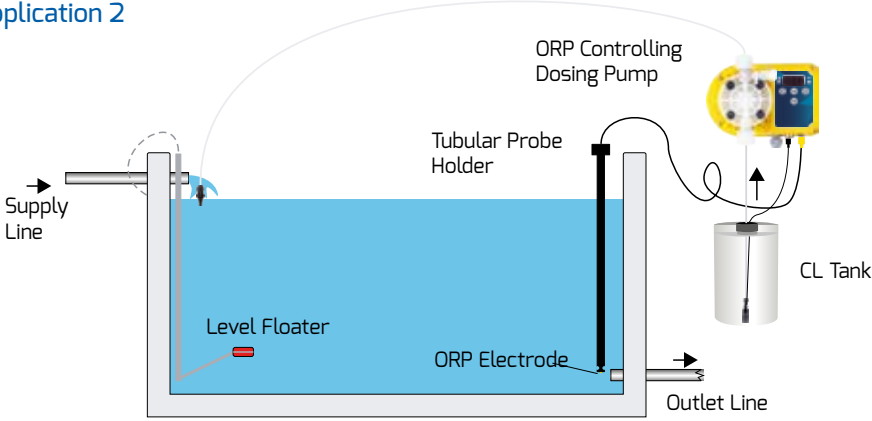

Sample Application 3

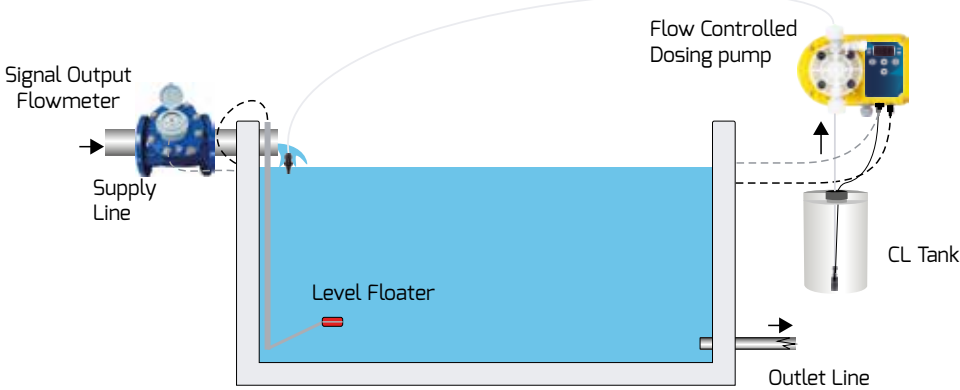

OPTIMA Analog Dosing Pump









- Design with adjustable stroke rate with potentiometer on it
- On/Off Button
- Thanks to vertical-mounted design easy and flexible installation and operation
- PVDF head set with high resistance to corrosive chemicals and all IP65 body
- Electromagnet controlled by electronic circuit and long-life Teflon (PTFE) diaphragm
- Reduced maintenance thanks to zirconium ball design
- PP With injection and suction accessories

Stock Code	Model	Lt/H	Max. Counter Pressure/Bar	Package Sizes/cm W-L-H	Packed Weight/Kg
307105010101000	DP OPTIMA A 5L/10B V220FAT	5	10	21 x 24 x 18	3,05
307104015101000	DP OPTIMA A 2,5L/15B V220FAT	2,5	15	21 x 24 x 18	3,05
307105010301000	DP OPTIMA A 5L/10B VPTFE 220FAT	5	10	21 x 24 x 18	3,05
307104015301000	DP OPTIMA A 2,5L/15B VPTFE 220FAT	2,5	15	21 x 24 x 18	3,05

The above products and the following spare parts are standard Viton O-Ring and teflon models. Contact with us for EPDM options.

Spare Parts - Options

Stock Code	Stock Name	Description	Included in Package
 600110800110000	SUCTION SET 4X6 V	Pp Suction Set With 4X6 mm Connection With Viton Oring. For V220 Fat Models.	✓
 600110700311000	INJECTION SET 4X6 V	Pp Injection Set With 4X6 mm Connection With Viton Oring. For V220 Fat Models.	✓
 600110800160000	SUCTION SET 4X6 V-PTFE	Pp Suction Set With 4X6 mm Connection. For V-Ptfe 220 Fat Models.	✓
 600110700316000	INJECTION SET 4X6 V-PTFE	Pp Injection Set With 4X6 mm Connection. For V-Ptfe 220 Fat Models.	✓
 600110500100000	HOSE SET V	Viton Hose Set For Suction, Injection And Air Bleeding Valve Connections. For 2L/10B - 5L/7B And 10L/5B Models	✓
 600511010120100	YP CHECK VALVE SET 4050 VITON	Up and Down Viton Checkvalve sets for Head Sets 40 and 50	✓
 500010079100010	BASE FIXING BRACKET DP	Dosing Pump Foot Mount Bracket For Mounting A Flat Surface. For All Models.	✗

OPTIMA SERIES SPECIFICATIONS

Model	Max./Lt	Max./P	Stroke/dk	ml /Stroke	Suction Connection	Injection Connection	Supply Voltage	Watt	Product Weight	Body	Max. Temp.
	Lt / h	Bar	stroke	ml	mm	mm	Volt	W	kg	IP	°C
5L/10B	5	10	120	0,694	4x6	4x6	230 VAC 50-60 Hz	20	2,16	65	For Ambient: 0-45 For Chemical: 0-40
	6	6		0,833							
	7,5	3		1,042							
	10	1		1,458							
2,5L/15B	2,5	15	150	0,278	4x6	4x6	230 VAC 50-60 Hz	20	2,16	65	For Ambient: 0-45 For Chemical: 0-40
	3	10		0,333							
	4	6		0,444							
	8	1		0,889							

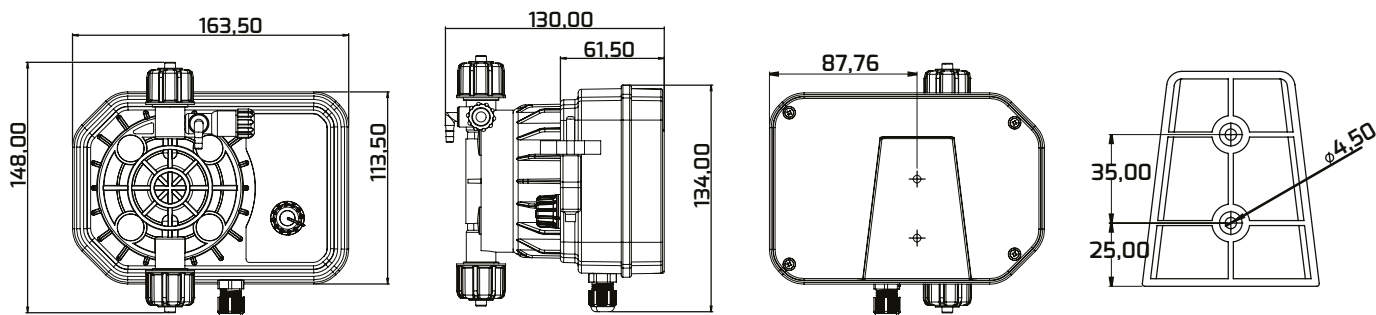

DP OPTIMA **A**

5L/10B

V220FAT

Code	Description
A	Analog, On/Off Button Dosing Pump

Code	Description
5L/10B	It can dose maximum 5 liters against to maximum 10 bar counter pressure.
2,5L/15B	It can dose maximum 2.5 liters against to maximum 15 bar counter pressure.

Code	Pump Head	Suction-Injection Set	O-Rings	Injection Hose	Suction-Air Bleed Hose	Bleed Outlet
V	PVDF	PP	Viton	PE	PVC	Manual
E	PVDF	PP	EPDM	PE	PVC	Manual
VPTFE	PVDF	PP	PTFE	PE	PVC	Manual

NANO A Analog Dosing Pump







- Design with adjustable stroke rate with potentiometer on it
- Thanks to vertical-mounted design easy and flexible installation and operation
- PVDF-G head set providing high resistance to corrosive chemicals
- Electromagnet controlled by electronic circuit and long-life Teflon (PTFE) diaphragm
- Reduced maintenance thanks to zirconium ball design
- With PP injection and suction accessories

Stock Code	Model	Lt/H	Max. Counter Pressure/Bar	Package Sizes/cm W-L-H	Packed Weight/Kg
302105005101000	DP NANO A 5L/5B V220FAT	5	5	21 x 24 x 18	2,45
302102010101000	DP NANO A 2L/10B V220FAT	2	10	21 x 24 x 18	2,45

The above products and the following spare parts are standard Viton O-Ring models. For EPDM O-Ring models, contact with us.

Spare Parts - Options

	Stock Code	Stock Name	Description	Included in Package
	600110800110000	SUCTION SET 4X6 V	Pp Suction Set With 4X6 mm Connection With Viton Oring. For All Models	✓
	600110700311000	INJECTION SET 4X6 V	Pp Injection Set With 4X6 mm Connection With Viton Oring. For 2L/10B - 5L/7B And 10L/5B Models.	✓
	600110500100000	HOSE SET V	Viton Hose Set For Suction,Injection And Air Bleeding Valve Connections.For 2L/10B - 5L/7B And 10L/5B Models	✓
	600511010120100	YP CHECK VALVE SET 4050 VITON	Up and Down Viton Checkvalve sets for Head Sets 40 and 50	✓

NANO SERIES TECHNICAL SPECIFICATIONS

Model	Max./Lt	Max./P	Stroke/dk	ml /Stroke	Suction Connection	Injection Connection	Supply Voltage	Watt	Product Weight	Body	Max. Temp.
	Lt / h	Bar	stroke	ml	mm	mm	Volt	W	kg	IP	°C
2L/10B	2	10	180	0,185	4x6	4x6	230 VAC 50 Hz	10	1,76	65	For Ambient: 0-45
A 5L/5B	5	5	180	0,463	4x6	4x6					For Chemical: 0-40

The flow-pressure graphs of the nano series dosing pumps can be found on page 197.

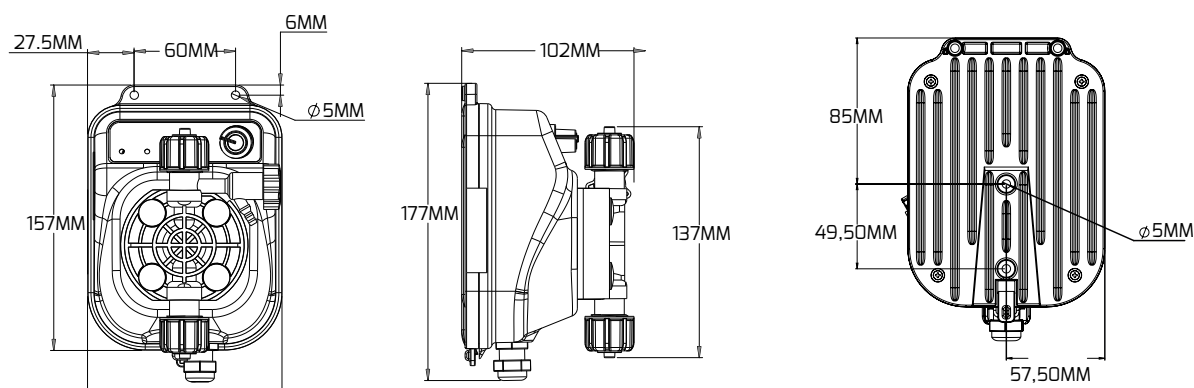

DP NANO **A**

2L/10B

V220FAT

Code	Description
A	Analog Dosing Pump

Code	Description
2L/10B	It can dose maximum 2 liters against to maximum 10 bar counter pressure.
5L/5B	it can dose maximum 5 liters against to maximum 5 bar counter pressure.

Code	Pump Head	Suction-Injection Set	O-Rings	Injection Hose	Suction-Air Bleed Hose	Bleed Outlet
V	PP	PP	Viton	PE	PVC	Manual
E	PP	PP	EPDM	PE	PVC	Manual

02 Electro-Mechanical Diaphragm Dosing Pumps

EMD Series



EMD-P

Electro-Mechanical Diaphragm Dosing Pump with Plastic Body

- Ideal solution for precise dosing of large quantities of liquid chemicals
- PP, SS 316 and PVDF pump head, couplings and check valves which can be selected according to the chemicals want to be dosed
- Manual 0-100% capacity setting when running or stopping.
- Ability to adjust capacity with the 4-20mA signal input motor driver

Stock Code	Model	Lt/H	Max. Counter Pressure/Bar	Package Sizes/cm W-L-H	Packed Weight/Kg
311014005241(XXX)	EMD P14L/5B 380 (XXX)	14	5	31 x 38 x 23	5,90 (PCP) 5,95 (PSS)
311032005251(XXX)	EMD P32L/5B 380 (XXX)	32	5	31 x 38 x 23	6,10 (PVCCP) 6,00 (PVDfCP)
311049005261(XXX)	EMD P49L/5B 380 (XXX)	49	5	31 x 38 x 23	7,40 (SSS)

Spare Parts - Options

	Stock Code	Stock Name	Description	Included in Package
	600112000110000	CONNECTION KIT EMD 11 PCP	9X12 mm And 20 mm Connection Parts Of The Emd Pump Head. For All Pcp Models.	✓
	600112000330000	CONNECTION KIT EMD 33 PVDFCP	9X12 mm And 20 mm Connection Parts Of The Emd Pump Head. For All Pvd fcp Models.	✓
	600112000440000	CONNECTION KIT EMD 44 PVCCP	9X12 mm And 20 mm Connection Parts Of The Emd Pump Head. For All Pvccp Models.	✓
	410160011100001	EMD CONNECTION KIT 9X12 PP	Pp Suction And Injection Kit For 9X12 mm Connection. For All Pcp Models	✗
	410160012200001	EMD CONNECTION KIT 20MM PP	Pp Suction And Injection Kit For 20 mm Connection. For All Pcp Models	✗
	410160021100001	EMD CONNECTION KIT PVC 9X12MM	Pp Suction And Injection Kit For 9X12 mm Connection. For All Pvccp Models	✗
	410160022200001	EMD CONNECTION KIT 20MM PVC	Pp Suction And Injection Kit For 20 mm Connection. For All Pvccp Models	✗
	410160031300001	EMD CONNECTION KIT PVDF 9X12MM	Pp Suction And Injection Kit For 9X12 mm Connection. For All Pvd f Models	✗
	410160032300001	EMD CONNECTION KIT PVDF 20MM PVC	Pp Suction And Injection Kit For 20 mm Connection. For All Pvd f Models	✗
	410170011100001	HOSE SET 9X12 PE 10M	9X12 mm Polyethylene Hose 10 Meters	✗

EMD-P TECHNICAL SPECIFICATIONS

Pump Type	Ø mm Diaphragm	Stroke / dk.		Capacity				Max. Pressure		Stroke mm	kW	Connections	Weight
		50Hz	60Hz	L1'	L/h	50Hz	60Hz	50Hz	60Hz				
EMD P14L/5B 380 (XXX)	66	42	50	0,23	0,28	14	17	5	72,5	4	0,09	3/4"	4,50 (PCP) 4,55 (PSS)
EMD P32/5B 380 (XXX)	66	85	102	0,53	0,64	32	38	5	72,5	4	0,09	3/4"	6,00 (SSS) 4,60 (PVDFCP)
EMD P49L/5B 380 (XXX)	66	128	153	0,82	0,98	49	59	5	72,5	4	0,09	3/4"	4,70 (PVCCP)

* Pump installation connection is 3/4" external threaded. Optionally, 3/8" internal thread and 9x12mm hose connection accessories are included in the package.

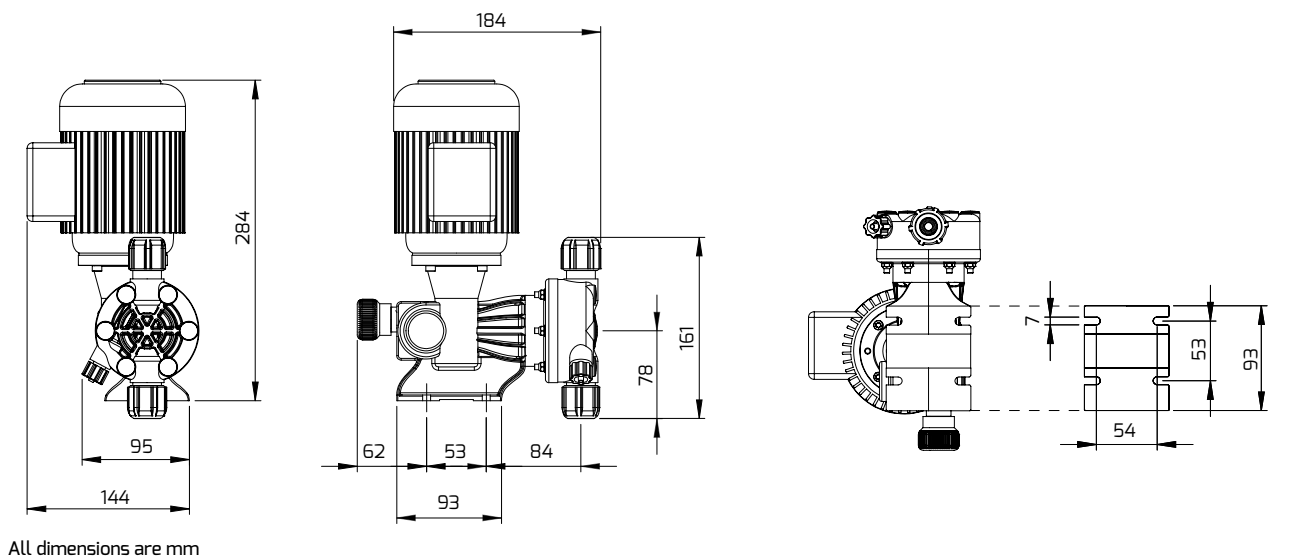

All dimensions are mm

EMD **P**

14L5B

380 XXX

Code	Description
P	Electro-Mechanical Diaphragm Dosing Pump with Plastic Body

Code	Description
14L/5B	It can dose maximum 14 liters against to maximum 5 bar counter pressure.
32L/5B	It can dose maximum 32 liters against to maximum 5 bar counter pressure.
49L/5B	It can dose maximum 49 liters against to maximum 5 bar counter pressure.

Code	Pump Head	Ball	Under Ball Component	Diaphragm
PCP	PP	Ceramic	PTFE	PTFE
PSS	PP	S.S.316	S.S.316	PTFE
SSS	S.S.316	S.S.316	S.S.316	PTFE
PVDFCP	PVDF	Ceramic	PTFE	PTFE
PVCCP	PVC	Ceramic	PTFE	PTFE

02 Electro-Mechanical Diaphragm Dosing Pumps

EMD Series



EMD-M

Electromechanical Diaphragm Dosing Pump with Metal Body

- Ideal solution for precise dosing of large quantities of liquid chemicals
- PP, PVC, S.S.316 and PVDF pump head, couplings and check valves which can be selected according to the chemicals want to be dosed
- Manual 0-100% capacity setting when running or stopping.
- Ability to adjust capacity with the 4-20mA signal input motor driver

Stock Code	Model	Lt/H	Max. Counter Pressure/Bar	Package Sizes/cm W-L-H	Packed Weight/Kg
310050007101(XXX)	EMD M50L/7B 380 (XXX)	50	7	41 x 58 x 33	13,65 (PCP) 13,70 (PSS)
310100007121(XXX)	EMD M100L/7B 380 (XXX)	100	7	41 x 58 x 33	14,10 (PVCCP) 13,90(PVDFCP)
310150007131(XXX)	EMD M150L/7B 380 (XXX)	150	7	41 x 58 x 33	18,20 (SSS)
310240005331(XXX)	EMD M200L/5B 380 (XXX)	200	5	41 x 58 x 33	14,85 (PVCXP) 14,90 (PVCSS) 15,10(PVDFXP) 19,40 (SSS)
310360005331(XXX)	EMD M310L/5B 380 (XXX)	310	5	41 x 58 x 33	
310460003331(XXX)	EMD M420L/3B 380 (XXX)	420	3	50 x 62 x 32	15,85 (PVCXP) 15,90 (PVCSS) 16,10(PVDFXP)
310630003431(XXX)	EMD M630L/3B 380 (XXX)	630	3	50 x 62 x 32	20,40 (SSS)

Spare Parts - Options

	Stock Code	Stock Name	Description	Included in Package
	600112000110000	CONNECTION KIT EMD 11 PCP	9X12 mm And 20 mm Connection Parts Of The Emd Pump Head. For All Pcp Models.	✓
	600112000330000	CONNECTION KIT EMD 33 PVDFCP	9X12 mm And 20 mm Connection Parts Of The Emd Pump Head. For All Pvdhcp Models.	✓
	600112000440000	CONNECTION KIT EMD 44 PVCCP	9X12 mm And 20 mm Connection Parts Of The Emd Pump Head. For All Pvccp Models.	✓
	410160011100001	EMD CONNECTION KIT 9X12 PP	Pp Suction And Injection Kit For 9X12 mm Connection For All Pcp Models	✗
	410160012200001	EMD CONNECTION KIT 20MM PP	Pp Suction And Injection Kit For 20 mm Connection For All Pcp Models	✗
	410160021100001	EMD CONNECTION KIT PVC 9X12MM	Pp Suction And Injection Kit For 9X12 mm Connection For All Pvccp Models	✗
	410160022200001	EMD CONNECTION KIT 20MM PVC	Pp Suction And Injection Kit For 20 mm Connection For All Pvccp Models	✗
	410160031300001	EMD CONNECTION KIT PVDF 9X12MM	Pp Suction And Injection Kit For 9X12 mm Connection For All Pvdhcp Models	✗
	410160032300001	EMD CONNECTION KIT PVDF 20MM PVC	Pp Suction And Injection Kit For 20 mm Connection For All Pvdhcp Models	✗
	410170011100001	HOSE SET 9X12 PE 10M	9X12 mm Polyethylene Hose 10 Meters	✗

EMD-M TECHNICAL SPECIFICATIONS

Pump Type	Ø mm Diaphragm	Stroke / dk.		Capacity				Max. Pressure		Stroke mm	kW	Connection	Weight
				L1'		L/h							
		50Hz	60Hz	50Hz	60Hz	50Hz	60Hz	Bar	Psi				
EMD M50L/7B 380(XXX)	110	40	48	0,83	1	50	60	7	101,5	5	0,25	3/4"	12,15 (PCP) 12,20 (PSS)
EMD M100L/7B 380(XXX)	110	80	96	1,66	2	100	120	7	101,5	5	0,25	3/4"	16,70 (SSS) 12,40(PVDFCP)
EMD M150L/7B 380(XXX)	110	120	145	2,5	3	150	180	7	101,5	5	0,25	3/4"	12,60 (PVCCP)
EMD M200L/5B 380 (XXX)	120	80	96	4	4,83	200	290	5	72,5	10	0,37	3/4"	13,35 (PVCXP) 13,40 (PVCSS)
EMD M310L/5B 380 (XXX)	120	120	145	5,166	6,2	310	372	5	72,5	10	0,37	3/4"	13,60(PVDFPXP) 17,90 (SSS)
EMD M420L/3B 380 (XXX)	140	120	145	7	8,4	420	504	3	43,5	10	0,37	1"	13,35 (PVCXP) 13,40 (PVCSS)
EMD M630L/3B 380 (XXX)	140	120	145	10,5	12,58	630	755	3	43,5	15	0,37	1"	14,60(PVDFPXP) 18,90 (SSS)

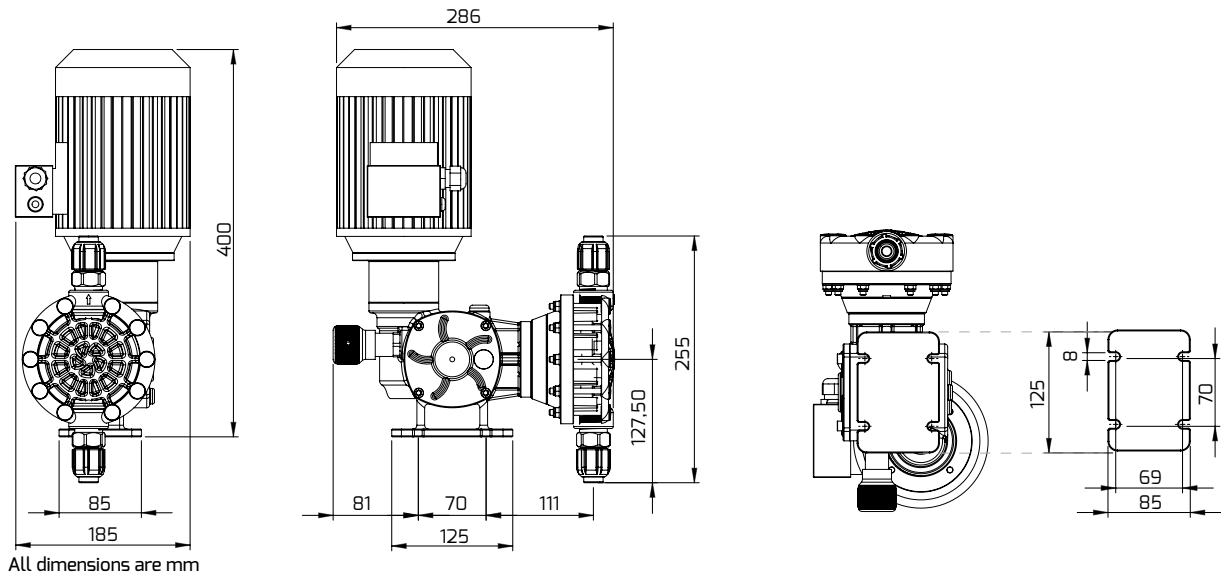

All dimensions are mm

EMD **M**

50L/7B

380 XXX

Code	Description
M	Electromechanical Diaphragm Dosing Pump with Metal Body

Code	Description
50L/7B	It can dose maximum 50 liters against to maximum 7 bar counter pressure.
100L/7B	It can dose maximum 100 liters against to maximum 7 bar counter pressure.
150L/7B	It can dose maximum 150 liters against to maximum 7 bar counter pressure.
240L/5B	It can dose maximum 240 liters against to maximum 5 bar counter pressure.
310L/5B	It can dose maximum 310 liters against to maximum 5 bar counter pressure.
420L/3B	It can dose maximum 420 liters against to maximum 3 bar counter pressure.
630L/3B	It can dose maximum 630 liters against to maximum 3 bar counter pressure.

Code	Pump Head	Ball	Under Ball Component	Diaphragm
PCP	PP	Ceramic	PTFE	PTFE
PSS	PP	S.S.316	S.S.316	PTFE
SSS	S.S.316	S.S.316	S.S.316	PTFE
PVDFCP	PVDF	Ceramic	PTFE	PTFE
PVCCP	PVC	Ceramic	PTFE	PTFE
PVCXP	PVC	Pyrex	PTFE	PTFE
PVCSS	PVC	S.S.316	S.S.316	PTFE
PVDFPXP	PVDF	Pyrex	PTFE	PTFE













ASPENDOSE A

Peristaltic Dosing Pump

- OEM head options
- Adjustable flow rate, rapid button
- PP, chemical resistant IP 65 body
- On-Off switch
- Long-life pulley system, Chemical discharge end
- *Model options for detergent(D), rinse aid (R) and pH-Chlorine (A) dosing
- Easy assembly and disassembly thanks to the rear cover slide

Stock Code	Model	Lt/H	Max. Counter Pressure/Bar	Package Sizes/cm W-L-H	Packed Weight/Kg
340051005201000	ASPENDOSE A 5,1L/0,5B D 220AT	5,1	0,5	20 x 15 x 13	0,78
340028030301000	ASPENDOSE A 2,8L/3B R 220AT	2,8	3	20 x 15 x 13	0,78
340051005101000	ASPENDOSE A 5,1L/0,5B A 220AT	5,1	0,5	20 x 15 x 13	0,78
340028030101000	ASPENDOSE A 2,8L/3B A 220AT	2,8	3	20 x 15 x 13	0,78

Spare Parts - Options

Stock Code	Stock Name	Description	Included in Package
 600110800100100	SUCTION SET 4X6 ASPENDOSE CERAMIC	Suction Set With 4X6 mm Connection, Pp / Ceramic. For All Models.	✓
 600110700311000	INJECTION SET 4X6 V	Pp Injection Set With 4X6 mm Connection With Viton Oring. For A Models.	✓
 600110700113100	INJECTION SET PERISTALTIC 4X6 PVDF	Pvdf Injection Kit With 4X6 mm Connection. For D Models.	✓
 600110700211100	INJECTION SET METAL 4X6 V ASPENDOSE	Injection Kit Pvdf-Ss With 4X6 mm Connection. For R Models.	✓
 500010066120000	NOZZLE KIT FOR HOSE ASPENDOSE	Pvdf Nozzle Of Gradual Hose And Injection Kit. For R Models	✓
 600110500000000	HOSE SET 4X6 ASPENDOSE	Hose Set For Suction And Injection Connections. For All Models	✓
 600110400800000	MOUNTING SET ASPENDOSE	Set Of Screws And Anchors For Wall Mounting. For All Models	✓
 410200011000001	T FITTING KIT PVDF	T Pvdf Of Gradual Hose And Injection Kit Connection Parts. For R Models.	✗
 600505020001000	YP ASPENDOSE HOSE SET A-D	DP ASPENDOSE Peristaltic Tupe Set A-D	✓
 600505030002000	YP ASPENDOSE HOSE SET R	DP ASPENDOSE Peristaltic Tupe Set R	✓

ASPENDOSE A SERIES TECHNICAL SPECIFICATIONS

Model	Application Chemical	Min./Lt Lt / h	Max./Lt Lt / h	Max./P Bar	Suction Connection mm	Injection Connection mm	Supply Voltage Volt	Watt W	Product Weight kg	Body IP	Max. Temp. °C	
A	5,1L/0,5B D	D (Detergent)	0,7	5,1	0,5	4 X 6	4 X 6	95-260 VAC 50-60 Hz	3,5	0,635	65	For Ambient: 0-45 For Chemical: 0-45
	2,8L/3B R	R (Polisher)	0,5	2,8	3	4 X 6	4 X 6					
	5,1L/0,5B A	A (pH-CL)*	0,7	5,1	0,5	4 X 6	4 X 6					
	2,8L/3B A	A (pH-CL)*	0,5	2,8	3	4 X 6	4 X 6					

* For pH: Max. 40% H₂SO₄ (Sulfuric Acid) For CL: Max. 16% NaOCl (Sodium Hypochlorite)

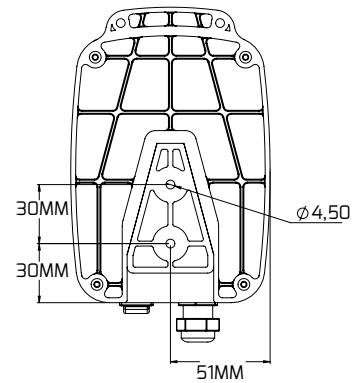
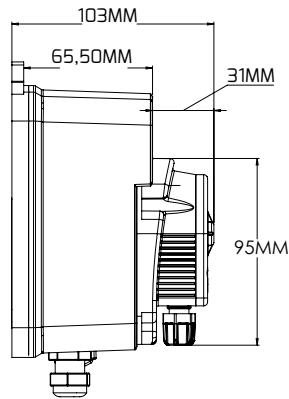
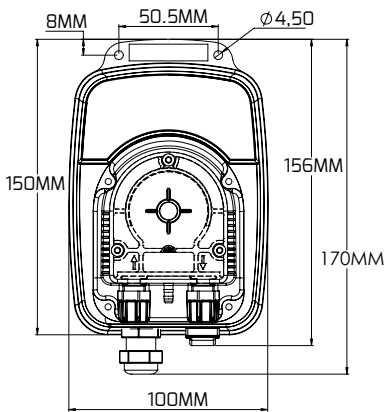

ASPENDOSE **A**

5,1L/0,5B

D,220AT

Code	Description
A	A Peristaltic Dosing Pump

Code	Description
5,1L/0,5B	It can dose maximum 5,1 liters against to maximum 0,5 bar counter pressure.
2,8L/3B	It can dose maximum 2,8 liters against to maximum 3 bar counter pressure.
5,1L/0,5B	It can dose maximum 5,1 liters against to maximum 0,5 bar counter pressure.
2,8L/3B	It can dose maximum 2,8 liters against to maximum 3 bar counter pressure.

Code	OEM Body	Suction-Injection Set	Number of reels	Peristaltic Hose	Suction-Injection-Discharge Hose
A	PP	PP	*3 - 2	*Norprene, Silicone	PVC - PE - PVC
D	PP	PP - PVDF	3	Norprene	PVC - PE - PVC
R	PP	PP - PVDF/SS	2	Silicon	PVC - PE - PVC

* 3 reels for 5.1L/ 0.5B and 2 reels for 2.8L/ 3B.

* Norprene for 5.1L/ 0.5B is silicone for 2.8L/ 3B.

ASPENDOSE DMS

Digital, Level Controlled, Volumetric Peristaltic Dosing Pump









- Digital display, Precise dosing with microcontroller technology, time adjustment and user password parameters
- Easy menu content and user-friendly button technology
- Volumetric proportional dosing when connected to the water meter or flow meters
- 4-20 mA analog input, liquid level control alarm relay
- Programmable fluid level or flow control
- Easy and flexible installation, operation thanks to vertical slide wall mounting or optional mounting foot
- All-plastic body for high resistance to corrosive chemicals
- Monitoring the pump capacity on the screen in mLt/H and performing flow calibration
- Easy maintenance and different capacity options thanks to OEM head options
- With Injection and suction fluid level sensor accessories

Stock Code	Model	Lt/H	Max. Counter Pressure/Bar	Package Sizes/cm W-L-H	Packed Weight/Kg
342043005100000	ASPENDOSE DMS 4,3L/0,5B A ACFAT	4,3	0,5	12 x 21 x 13	1,615
342025030100000	ASPENDOSE DMS 2,5L/3B A ACFAT	2,5	3	12 x 21 x 13	1,615

* You can select the accessory from the probe holder table on page 17.

Spare Parts - Options

Stock Code	Stock Name	Description	Included in Package
 600110800110000	SUCTION SET 4X6 VS	Pp Suction Set With 4X6 mm Connection And Level Sensor -With Viton Oring. For All Models.	✓
 600110700310000	INJECTION SET 4X6 V	Pp Injection Set With 4X6 mm Connection With Viton Oring. For 2L/10B - 5L/7B And 10L/5B Models.	✓
 600110500100000	HOSE SET V	Viton Hose Set For Suction,Injection And Air Bleeding Valve Connections.For 2L/10B - 5L/7B And 10L/5B Models	✓
 610103050000001	CABLE SET SIGNAL EXTERNAL DP LARA	Cable Set With Mic Connection For Signal inputs And Alarm Output.	✓
 500010079100010	BASE FIXING BRACKET DP	Dosing Pump Foot Mount Bracket For Mounting A Flat Surface. For All Models.	✗
 600505020001000	YP ASPENDOSE HOSE SET A-D	DP ASPENDOSE Peristaltic Tupe Set A-D	✓
 600505030002000	YP ASPENDOSE HOSE SET R	DP ASPENDOSE Peristaltic Tupe Set R	✓

*: For models with PVDF kits. Indicate during your order

ASPENDOSE DMS SERIES SPECIFICATIONS

Model	Min./Lt Lt / h	Max./Lt Lt / h	Max./P Bar	Suction Connection mm	Injection Connection mm	Supply Voltage Volt	Watt W	Product Weight kg	Body IP	Max. Temp. °C
ASPENDOSE DMS	0,001	4,3	0,5	4x6	4x6	AC 100-240VAC 50-60 Hz	AC 6-8W	0,825	X5	For Ambient: 0-45
	0,001	2,5	3	4x6	4x7	DC 12-28VDC	DC 4W			For Chemical: 0-45

* For pH: Max. 40% H₂SO₄ (Sulfuric Acid)

* For CL: Max. 16% NaOCl (Sodium Hypochlorite)

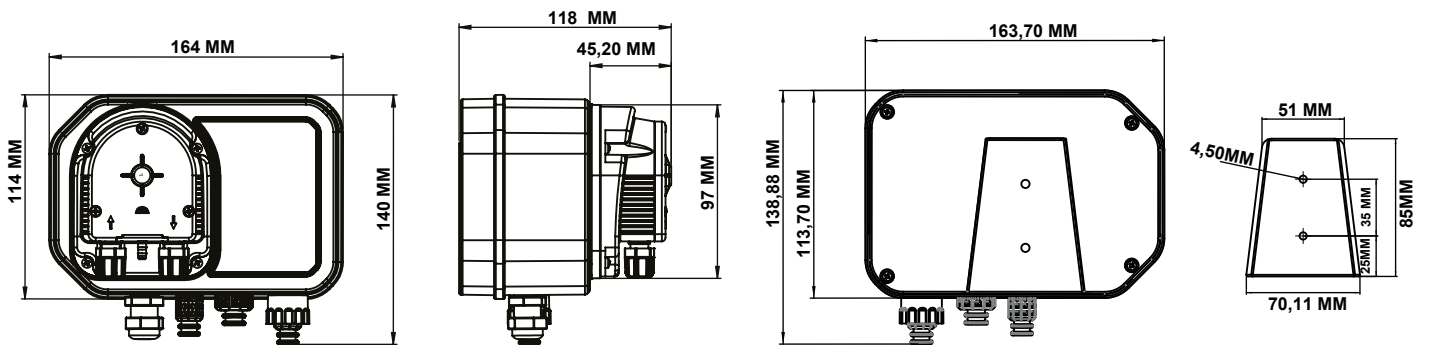

DP ASPENDOSE **DMS**

4,3L/0,5B

A ACFAT

Code	Description
DMS	Digital, Level Controlled, Volumetric Peristaltic Dosing Pump

Code	Description
4,3L/0,5B	It Can Dosage Up to 4.3 Liters Up to 0.5 Bar Counter Pressure.
2,5L/3B	It Can Dosage Up to 2.5 Liters Up to 3 Bar Counter Pressure.

Code	OEM Body	Suction-Injection Set	Reel Number	Peristaltic Hose	Suction-Injection-Discharge Hose
A	PP	PP	*3 - 2	*Norprene, Silicone	PVC - PE - PVC

* 3 reels for 4.3L/ 0.5B and 2 reels for 2.5L/ 3D.

* Norprene for 4.3L/0.5B is silicone for 2.5L/ 3D.

ASPENDOSE PR

Digital, Level Controlled, pH&ORP, Volumetric Peristaltic Dosing Pump









- Digital display, Precise dosing with microcontroller technology, time adjustment and user password parameters
- Easy menu content and user-friendly button technology
- ORP (REDOX) or pH measurement with standard combined electrodes
- Fully digital tuning and automatic calibration using buffer liquid
- To be able to enter measurement value definition time at opening (0 - 60 min.)
- Volumetric proportional dosing when connected to the water meter or flow meters (Volumetric connection cable not included)
- 4-20 mA analog input, liquid level control alarm relay
- Programmable fluid level or flow control
- Easy and flexible installation, operation thanks to vertical slide wall mounting or optional mounting foot
- All-plastic body for high resistance to corrosive chemicals
- Monitoring the pump capacity on the screen in mLt/H and performing flow calibration
- Easy maintenance and different capacity options thanks to OEM head options
- With Injection and suction fluid level sensor accessories

Stock Code	Model	Lt/H	Max. Counter Pressure/Bar	Package Sizes/cm W-L-H	Packed Weight/Kg
341043005100000	ASPENDOSE PR 4,3L/0,5B A ACFAT	4,3	0,5	12 x 21 x 13	1,615
341025030100000	ASPENDOSE PR 2,5L/3B A ACFAT	2,5	3	12 x 21 x 13	1,615

* You can select the accessory from the probe holder table on page 17.

Spare Parts - Options

Stock Code	Stock Name	Description	Included in Package
 600110800110000	SUCTION SET 4X6 VS	Pp Suction Set With 4X6 mm Connection And Level Sensor -With Viton Oring. For All Models.	✓
 600110700310000	INJECTION SET 4X6 V	Pp Injection Set With 4X6 mm Connection With Viton Oring. For 2L/10B - 5L/7B And 10L/5B Models.	✓
 600110500100000	HOSE SET V	Viton Hose Set For Suction,Injection And Air Bleeding Valve Connections.For 2L/10B - 5L/7B And 10L/5B Models	✓
 610103050000001	CABLE SET SIGNAL EXTERNAL DP LARA	Cable Set With Mic Connection For Signal inputs And Alarm Output.	✓
 500010079100010	BASE FIXING BRACKET DP	Dosing Pump Foot Mount Bracket For Mounting A Flat Surface. For All Models.	✗
 600505020001000	YP ASPENDOSE HOSE SET A-D	DP ASPENDOSE Peristaltic Tupe Set A-D	✓
 600505030002000	YP ASPENDOSE HOSE SET R	DP ASPENDOSE Peristaltic Tupe Set R	✓

*: PVDF is for mass models. Indicate during your order

ASPENDOSE DMS SERIES TECHNICAL SPECIFICATIONS

Model	Min./Lt Lt / h	Max./Lt Lt / h	Max./P Bar	Suction Connection mm	Injection Connection mm	Supply Voltage Volt	Watt W	Product Weight kg	Body IP	Max. Temp. °C
ASPENDOSE PR	0,001	4,3	0,5	4x6	4x6	AC 100-240VAC 50-60 Hz	AC 6-8W	0,825	X5	For Ambient: 0-45
	0,001	2,5	3	4x6	4x7	DC 12-28VDC	DC 4W			For Chemical: 0-45

* For pH: Max. 40% H₂SO₄ (Sulfuric Acid)

* For CL: Max. 16% NaOCl (Sodium Hypochlorite)

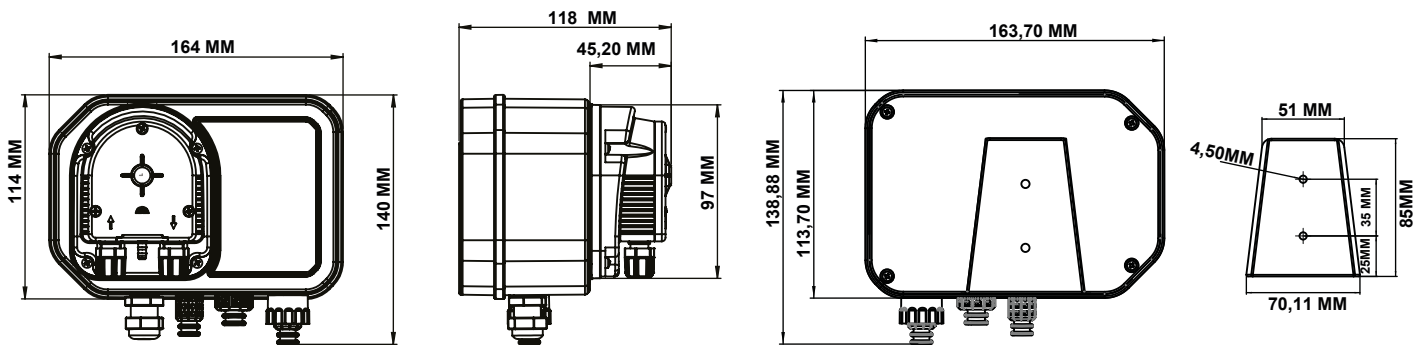

DP ASPENDOSE **PR**

4,3L/0,5B

A ACFAT

Code	Description
PR	Digital, Level Controlled, pH&ORP, Volumetric Peristaltic Dosing Pump

Code	Description
4,3L/0,5B	It can dose maximum 4,3 liters against to maximum 0,5 bar counter pressure.
2,5L/3B	It can dose maximum 2,5 liters against to maximum 3 bar counter pressure.

Code	OEM Body	Suction-Injection Set	Number of reels	Peristaltic Hose	Suction-Injection-Discharge Hose
A	PP	PP	*3 - 2	*Norprene, Silicone	PVC - PE - PVC

* 3 reels for 4.3L/ 0.5B and 2 reels for 2.5L/ 3D.

* Norprene for 4.3L/0.5B is silicone for 2.5L/ 3D.

ASPENDOSE PER 200









Remote controlled, Double Head Peristaltic Dosing Pump



- Double oem peristaltic (detergent and polisher) on single body.
- Operation with dual signal input (Filling, Rinsing)
- 24 VAC-VDC and 220 VAC (with transformer) operation
- Operator control and control input with LCD display that does not require batteries for menu setting
- Suitable design for 3rd pump addition
- Individual cycle, standby and time-regulated, individual prime mode for 3 pumps
- Monitoring the running times of the motors, limiting the pump running time
- Independent filling and rinsing settings can be entered
- Easy assembly and intervention with hinged, special angle, opening front cover, slide mounting apparatus
- It has motor protection feature with electronic circuit.
- Being able to work in all conveyor, guillotine and under-counter machines thanks to the durable roller system, motor, and hose structure

Stock Code	Model	Description
202010050000000	PER 200 ASPENDOSE ANTECH	Double Headed Peristaltic Dosing Pump For Dishwasher
202120050000000	PER 100 ASPENDOSE ANTECH	Additional 3rd Pump for Per 200
410180011200001	PER USER ASPENDOSE ANTECH	Digital External Control For Per 200

Spare Parts - Options

	Stock Code	Stock Name	Description	Included in Package
	600110800100100	SUCTION SET 4X6 ASPENDOSE CERAMIC	Suction Set With 4X6 mm Connection, Pp / Ceramic.For All Models.	✓
	600110700113100	INJECTION SET ASPENDOSE 4X6 PVDF	Pvdf Injection Kit With 4X6 mm Connection. For Detergent Side.	✓
	600110700211100	INJECTION SET METAL 4X6 V ASPENDOSE	Injection Kit Pvdf-Ss With 4X6 mm Connection.For Rinse Side.	✓
	500010066120000	NOZZLE KIT FOR HOSE ASPENDOSE	Pvdf Nozzle Of Gradual Hose And Injection Kit. For Rinse Side.	✓
	600110500000000	HOSE SET 4X6 ASPENDOSE	Hose Set For Suction And Injection Connections. For All Models	✓
	600110400800000	MOUNTING SET ASPENDOSE	Set Of Screws And Anchors For Wall Mounting. For All Models	✓
	705130100000001	E POWER TRANSFORMATOR 12W 23V WITH CABLE ELKOM (1-3)	220Vac- 24V Transformer. For Per 200 Models	✓
	410200011000001	T FITTING KIT PVDF	T Pvdf Of Gradual Hose And Injection Kit Connection Parts. For Rinse Side.	✗

ASPENDOSE PER 200 - 100 SERIES TECHNICAL SPECIFICATIONS

Model	Application Chemical	Min./Lt Lt / h	Max./Lt Lt / h	Max./P Bar	Suction Connection	Injection Connection	Supply Voltage Volt	Watt W	Product Weight kg	Body IP	Max. Temp. °C
					mm	mm					
PER 200	5,1L/0,5B D D (Detergent)	0,7	5,1	0,5	4 x 6	4 x 6	24 V AC-DC	AC 6-8W	0,635	65	For Ambient: 0-45 For Chemical: 0-45
	2,8L/3B R R (Rinse)	0,5	2,8	3	4 x 6	2 x 4	220 V AC*	DC 4W			
PER 100	5,1L/0,5B D D (Sanitizer)	0,7	5,1	0,5	4 x 6	4 x 6	24 V DC	DC 4W			

* Value provided by transformer

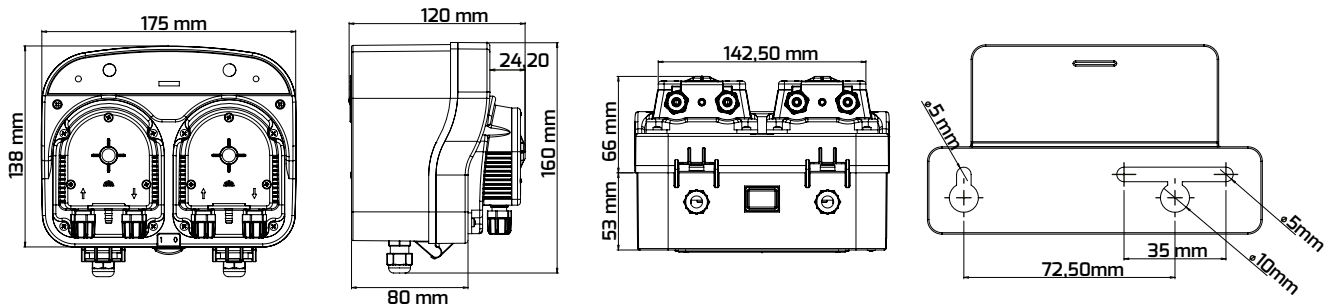

ASPENDOSE **PER**

200

Code	Description
PER	Remote controlled, Double Head Peristaltic Dosing Pump

Code	Description
200	Double headed, remote controlled peristaltic dosing pump for dishwasher
100	Additional 3rd pump for PER 200
USER	Digital external controller for Per 200

02 Peristaltic Dosing Pumps

Aspendose Series

ASPENDOSE PER 150









Double Head Peristaltic Dosing Pump



- Double oem peristaltic on single body (detergent and rinse)
- Single signal input operation
- 24 VAC-VDC and 220 VAC (with transformer) operation
- Individual adjustable flow rate adjustment for 2 pumps
- Individual premium buttons for 2 pumps
- Easy assembly and intervention with hinged, special angle, opening front cover, slide mounting apparatus
- Motor protection feature with electronic circuit.
- Being able to work in all conveyor, guillotine and under-counter machines thanks to the durable roller system, engine, and hose structure

Stock Code	Model	Description
202230050000000	PER 150 ASPENDOSE	Double-Headed Peristaltic Dosing Pump For Dishwashers.

Spare Parts - Options

	Stock Code	Stock Name	Description	Included in Package
	600110800100100	SUCTION SET 4X6 ASPENDOSE CERAMIC	Suction Set With 4X6 mm Connection, Pp / Ceramic.For All Models.	✓
	600110700113100	INJECTION SET ASPENDOSE 4X6 PVDF	Pvdf Injection Kit With 4X6 mm Connection. For Detergent Side.	✓
	600110700211100	INJECTION SET METAL 4X6 V ASPENDOSE	Injection Kit Pvdf-Ss With 4X6 mm Connection.For Rinse Side.	✓
	500010066120000	NOZZLE KIT FOR HOSE ASPENDOSE	Pvdf Nozzle Of Gradual Hose And Injection Kit. For Rinse Side.	✓
	600110500000000	HOSE SET 4X6 ASPENDOSE	Hose Set For Suction And Injection Connections. For All Models	✓
	600110400800000	MOUNTING SET ASPENDOSE	Set Of Screws And Anchors For Wall Mounting. For All Models	✓
	705130100000001	E POWER TRANSFORMATOR 12W 23V WITH CABLE ELKOM (1-3)	220Vac- 24V Transformer. For Per 200 Models	✓
	410200011000001	T FITTING KIT PVDF	T Pvdf Of Gradual Hose And Injection Kit Connection Parts. For Rinse Side.	✗

ASPENDOSE PER 150 SERIES TECHNICAL SPECIFICATIONS

Model	Application Chemical	Min./Lt Max./Lt Max./P			Suction Connection	Injection Connection	Supply Voltage	Watt	Product Weight	Body	Max. Temp.	
		Lt / h	Lt / h	Bar	mm	mm	Volt	W	kg	IP	°C	
PER 150	5,1L/0,5B D	D (Detergent)	0,7	5,1	0,5	4 x 6	4 x 6	24 V AC-DC	AC 6-8W	0,635	65	For Ambient: 0-45
	2,8L/3B R	R (Rinse)	0,5	2,8	3	4 x 6	2 x 4	220 V AC*	DC 4W			For Chemical: 0-45

* Value provided by transformer

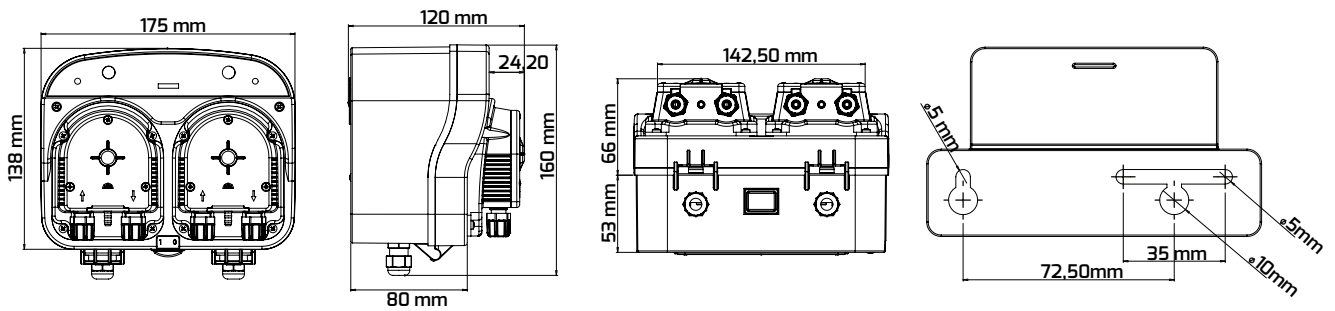

ASPENDOSE **PER**

150

Code	Description
PER	Double headed peristaltic dosing pump

Code	Description
150	Double headed manual peristaltic dosing pump for dishwasher

ASPENDOSE OEM







Peristaltic OEM Dosing Pump



- PP, chemical resistant body
- Chemical discharge end
- Long-life pulley system
- Model options for pH, Chlorine, Rinse and detergent dosing
- Direct 24 V DC supply
- Easy installation thanks to its compact structure

Stock Code	Model	Lt/H	Max. Counter Pressure/Bar	Package Sizes/cm W-L-H	Packed Weight/Kg
600521010100100	YP ASPENDOSE OEM 2,8L/3B 24VDC	2,8	0,5	12 x 12 x 8,5	0,28
600521010100200	YP ASPENDOSE OEM 5,1L/0,5B 24VDC	5,1	3	12 x 12 x 8,5	0,28

Spare Parts - Options

Stock Code	Stock Name	Description	Included in Package
 600110800100100	SUCTION SET 4X6 ASPENDOSE CERAMIC	Suction Set With 4X6 mm Connection, Pp / Ceramic. For All Models.	✗
 600110700311000	INJECTION SET ASPENDOSE 4X6 V	Pp Injection Set With 4X6 mm Connection With Viton Oring. For A Models.	✗
 600110700113100	INJECTION SET PERISTALTIC 4X6 PVDF	Pvdf Injection Kit With 4X6 mm Connection. For D Models.	✗
 600110700211100	INJECTION SET METAL 4X6 V ASPENDOSE	Injection Kit Pvdf-Ss With 4X6 mm Connection. For R Models.	✗
 500010066120000	NOZZLE KIT FOR HOSE ASPENDOSE	Pvdf Nozzle Of Gradual Hose And Injection Kit. For R Models	✗
 600110500000000	HOSE SET 4X6 ASPENDOSE	Hose Set For Suction And Injection Connections. For All Models	✗
 410200011000001	T FITTING KIT PVDF	T Pvdf Of Gradual Hose And Injection Kit Connection Parts. For R Models.	✗

ASPENDOSE OEM SERIES TECHNICAL SPECIFICATIONS

Model	Application Chemical	Min./Lt Lt / h	Max./Lt Lt / h	Max./P Bar	Suction Connection mm	Injection Connection mm	Supply Voltage Volt	Watt W	Product Weight kg	Body IP	Max. Temp. °C
OEM	5,1L/0,5B 24VDC pH-CL / Detergent	0,7	5,1	0,5	4 x 6	4 x 6	DC 24V	3,5	0,220	***65	For Ambient: 0-45 For Chemical: 0-45
	2,8L/3B 24VDC Rinse	0,5	2,8	3	4 x 6	**4 x 6					

* For pH: Max. 40% H₂SO₄ (Sulfuric Acid)

* For CL: Max. 16% NaOCl (Sodium Hypochlorite)

** Preferably 2 x 4

*** For the front surface

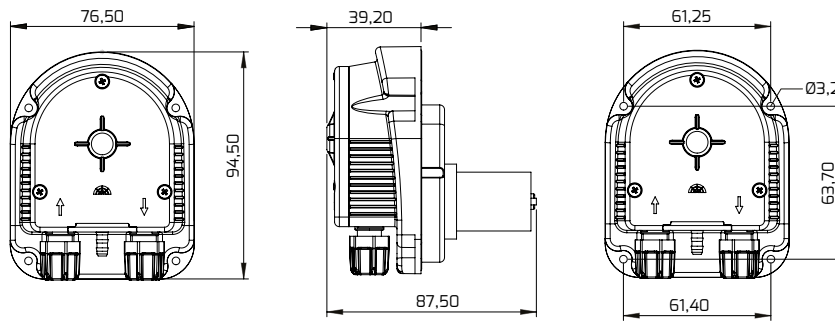

YP ASPENDOSE **OEM**

5,1L/0,5B

Code	Description
OEM	Peristaltic OEM Dosing Pump

Code	Description
2,8L/3B	It can dose maximum 2,8 liters against to maximum 3 bar counter pressure.
5,1L/0,5B	It can dose maximum 5,1 liters against to maximum 0,5 bar counter pressure.

03 Measurement and Control Devices

Measuring and Controlling Devices are the devices which display electronic signals from sensors, flow meters, meters, switches, management units and similar equipment on the screen directly or by evaluating in the protocol in it, and control dosing pumps, valves, blowers, lamps, sirens and similar process equipment based on these data.

AnTech measuring and controlling devices have the mechanism providing the right solution for your processes with fixed models and configurable models, and high-precision measurement technology. It offers professional solutions for your complex processes with the models specially designed for standard applications such as swimming pools, cooling towers, drinking water and wastewater. With the models with communication infrastructure, your measurements or other relevant conditions of your device are included in all industrial processes with global communication protocols. It offers process solutions that can be monitored and managed remotely.

AnTech offers its field experience of more than 25 years as solution packs in its product menus.



Measurement and Control Devices



OmniCon 1020 multi-parameter measuring and control device



OmniCon 1010 single parameter measuring and controlling device

OMNICON

Multi-Parameter Measuring and Controller

- Omnicon provides the opportunity to measure and control the parameters determined by the user according to the process structure with a single device thanks to its flexible structure.
- Omnicon alone does what two or more devices can do.
- Single Parameter, 2 parameters, 3 parameters and multimeter (up to 6 parameters) device option.
- Ability to work with 100-230V AC and 12V DC supply source,
- Graphic LCD display, adjustable light, contrast and sound, membrane keypad,
- Liquid level, flow sensor, counter, and external alarm inputs,
- 16-bit RISC microcontroller, real time clock,
- 3 levels of password protection,
- Retrospective 2048 log memory, displaying logs kept both as lists and graphics
- Menu system that reduces the need for user manual, English-Turkish language option,
- 5 types of calibration options, automatic fluid recognition, heat compensation
- Programmable relay outputs (Decrease, Increase, PID decrease, PID increase, Limit switch, Pulse width),
- Programmable counter input(Lt, m3 and countable), printer, OmniCon Visio and Info Panel connection
- Optionally 4 user adjustable 4-20 mA and 0-20 mA analog output,
- Optionally 4 4-20 mA Analog outputs,
- The device optionally supports many communication protocols.



Communications (Optional)

- >RS485
- >Ethernet
- >MODBUS RTU Master
- >MODBUS RTU Slave
- >MODBUS TCP Slave
- >Printer connection
- >Omnicon Web Interface



- pH
- Redox
- Conductivity
- TDS
- Free Chlorine
- Total Chlorine
- Combined Chlorine
- Chlorine Dioxide
- Ozone
- Hydrogen Peroxide
- Paracetic Acid
- Dissolved Oxygen
- Turbidity
- Humidity
- Temperature

Stock Code	Model	Description	Packaging Dimensions/cm W-L-H	Packed Weight/Kg
20101000000000	OMNICON PH	Ph Measurement And Controlling Device	27 x 30 x 13	1,65
20100100000000	OMNICON ORP	Orp Measurement And Controlling Device	27 x 30 x 13	1,65
20100010000000	OMNICON CON	Conductivity Measurement And Controlling Device	27 x 30 x 13	1,65
***	OMNICON GP	General Purpose Measurement And Control Device	27 x 30 x 13	1,65

Stock Code	Model	Description	Packaging Dimensions/cm W-L-H	Packed Weight/Kg
20101000000000	OMNICON PH ORP	Ph & Orp Measurement And Controlling Device	27 x 30 x 13	1,95
20101010000000	OMNICON PH CON	Ph & Conductivity Measurement And Controlling Device	27 x 30 x 13	1,95
20101001000000	OMNICON PH FCL	Ph & Free Chlorine Measurement And Controlling Device	27 x 30 x 13	1,95
***	OMNICON PH GP	Ph & General Purpose Measurement And Controlling Device	27 x 30 x 13	1,95
***	OMNICON 2 GP	2 Channel General Purpose Measurement And Control Device	27 x 30 x 13	1,95

Stock Code	Model	Description	Packaging Dimensions/cm W-L-H	Packed Weight/Kg
20101100000000	OMNICON PH ORP CON	Ph & Orp & Conductivity Measurement And Controlling Device	27 x 30 x 13	2,00
20101010000000	OMNICON PH ORP FCL	Ph & Orp & Free Chlorine Measurement And Controlling Device	27 x 30 x 13	2,00
***	OMNICON PH ORP GP	Ph & Orp & General Purpose Measurement And Controlling Device	27 x 30 x 13	2,00
***	OMNICON PH CON GP	Ph & Condcutivity & General Purpose Measurement And Controlling Device	27 x 30 x 13	2,00
***	OMNICON EXPERT	Ph & Condcutivity & Free Chlorine & Total Chlorine & Combine Chlorine Measurement And Controlling Device	27 x 30 x 13	2,00

*** The code is determined according to the selected parameter FCL: Free chlorine-TCL: Total Chlorine-CCL: Combined Chlorine

Stock Code	Model	Description
41004001000000	ADDITIONAL MODULE PH	Additional Electronic Module For Ph Measurement
41004002000000	ADDITIONAL MODULE ORP	Additional Electronic Module For Orp Measurement
41004004000000	ADDITIONAL MODULE CON	Additional Electronic Module For Conductivity Measurement
41004003000000	ADDITIONAL MODULE GP	Additional Electronic Module For Generalpurpose Measurement
41004017000000	ADDITIONAL MODULE GP24V	Additional Electronic Module For General Purpose 24V Measurement
41004001100000	ADDITIONAL MODULE PH PSMM	Additional Electronic Module For Ph Psmm Measurement
41004005000000	ADDITIONAL MODULE R5485	Additional Electronic Module For Modbus Rtu/Rs485 Communication
41004006000000	ADDITIONAL MODULE ETH	Additional Electronic Module For Modbus Tcp/Ethernet Communication
41004008000000	ADDITIONAL MODULE AN OUT	Additional Electronic Module For 4-20 Ma / 0-20 Ma Analog Output

OMNICON TECHNICAL SPECIFICATIONS

Supply

100-230VAC, 50-60Hz 0,1A Max
12VDC 1A Max* * (Optional)

pH

0.00 - 14.00pH Measuring Range
Solubility: 0.0lpH
Temperature Compensation: NTC, PT100, PT1000

ORP

0000 -1500mV Measuring Range
Solubility: 1mV

Conductivity /TDS

0.00 - 2000mS (Programmable)
Temperature Compensation: NTC, PT100, PT100Q
Low Measuring Limit: 0,0 -200,0 uS/ppm*
Solubility: 0.1 uS/ppm*
Ambient Measurement Limit: 0 - 20.000 uS/ppm*
Solubility: 1 uS/ppm*
High Measuring Limit: 0,0 - 200,0 mS/ppt*
Solubility: 0.01 mS/ppt* are valid units for TDS.

Potentiostatic

Free Chlorine 0-10 ppm
00.01 ppm solubility
* Chlorine Dioxide 0-10 ppm
00.01 ppm solubility *

GP Measurement Parameters

Total Chlorine
Connected Chlorine 0.00-0.50/2 .00/10.00/200 ppm*
Free Chlorine 0.01 ppm solubility*
Chlorine Dioxide 0.00 200 ppt(Prg) Measurement Range*
Ozone 0.01 ppt solubility *
Hydrogen Peroxide 0.01 ppm solubility*
Paracetic Acid

*: It may vary according to the measurement parameter.

DO (Dissolved Oxygen)

0.00 - 200 ppt (Prg) Measuring Range
0.01 ppt Solubility
Temperature Compensation: NTC, PT100, PT1000
Special salinity and air pressure parameters

TU (Turbidity)

0-4 / 0-40 / 0-400 (NTU)
0,001 / 00,01 / 000,1 (Solubility)
0-100 / 0-1,000 / 0-10,000 (FTU)
000,1 / 00,10 / 0,100 (Solubility)

Humidity

0,0 -100,0 rh% Measuring Range 0,1 rh% Solubility
Free Chlorine
0.00-10.00 ppm Measuring Range
Solubility: 0,01 ppm

Temperature

RTD-25.0 - -125.0°C Measuring Range 0.1°C Solubility
NTC -5,0 - 80,0°C Measuring Range 0,1 °C Solubility

Digital Inputs

2 liquid levels, 1 flow sensor (PNP, NPN),
1 pcs external alarm inputs
Programmable Counter input (Lt,m3, countable pcs)
(divider and multiplier option)

Outputs

4 5A 110-230VAC, *5A 12VDC or potential-free programmable relay outputs
(Decrease Control, Increase Control, PID increase control, PID decrease control, Counter, Timed, Alarm)

1 x 5A potential-free (NO-NC) alarm relay
*4 pcs 0-20mA, 4-20mA programmable analog outputs
(Linear output, Decrease Control, Increase Control, PID decrease control, PID increase control, Limit switch, Pulse width)

OmniCon 1010

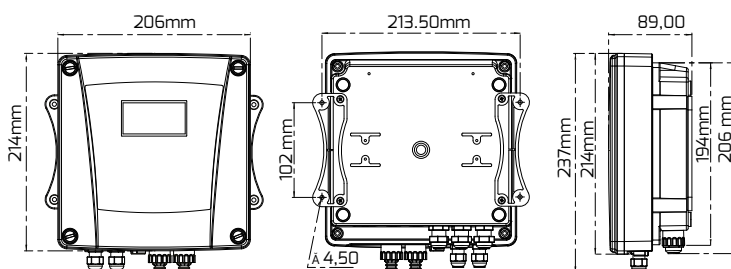

OmniCon 1020

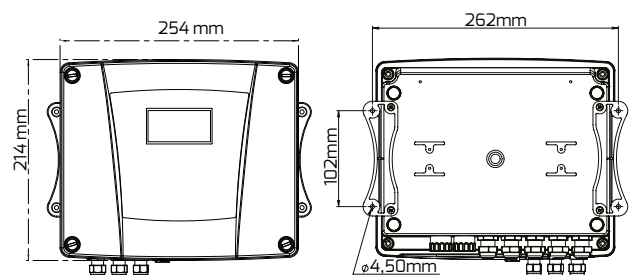

Remote Monitoring and Controlling System

Remote Monitoring Interface



- Tracking and controlling more devices than one over a single panel and application
- Remote monitoring
- Remote controlling (changing parameter set values, relay on-off-controlling dosage pump)
- Adding devices
- Backward data recording and reporting
- Communicating alarm information by sms and e-mail
- Device gps location.



How Does The System Work And Why Is It Used?

Remote monitoring system is used in order to monitor, record condition of parameters such as ph, conductivity, orp, free chloride, trace element, turbidity, solved oxygen, temperature, humidity and etc. measured through sensors by Omnicon systems operating in the plant, how such parameters work, what they control in a live environment and what kind of results have been obtained in this respect. One or more plants, devices can be monitored and controlled over a

Stock Code	Model	Description
41004018000000	ADDITIONAL WIFI MODULE OMNICON	Communication module via Omnicon WiFi

OMNICON WEB INTERFACE

Remote Monitoring Interface

Web Interface; It is a remote control and monitoring program optionally added to Omnicon devices. With Omnicon Web Interface;

- You can see the measurement parameters on your device instantly.
- You can monitor and report retrospective measurement records graphically and tabularly and save them as pdf on your computer.
- You can change the set settings and check the relays.
- No program is needed to connect to the Omnicon Web Interface. You can start your device's web interface directly from your web browser (Internet Explorer, Google chrome, etc.).



- Your Omnicon device can be connected to your computer via a modem or directly.
- You can also connect directly to the Omnicon Web interface with Industrial type wireless modems.

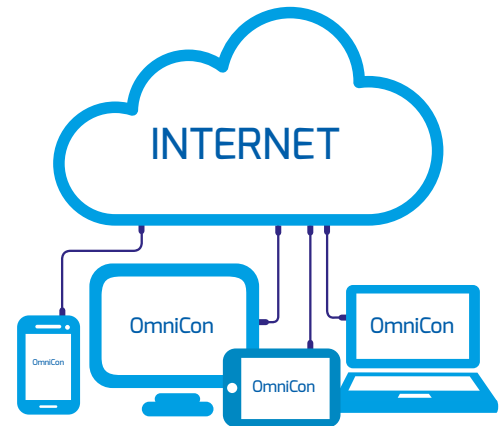

- With the External Port that you will open to your modem, you can connect from off-site computers, smartphones, and tablets.



- Login with user password

- Ability to see measurements instantly, change role set values and control equipment such as pump or valve connected to the relay.



- Ability to view and print retrospective measurement records

Stock Code

Model

Description

41012002000000 | OMNICON WEB INTERFACE

Monitoring And Controlling interface On internet



POOLSAVER TETRA

pH & ORP Measuring and Controller

- It is a digital pH (0.00 - 14.00) and ORP (0 - 1600mV) measurement and control device.
- Two relay outputs
- Adjusting rod using buffer liquid, fully digital adjustment without the need for screwdrivers and automatic calibration
- The ideal solution for swimming pools of all sizes thanks to its proportional control feature
- IP65 plastic body with high resistance to corrosive chemicals
- Two fluid level control inputs
- User password

Stock Code	Model	Description	Package Sizes/cm W-L-H	Packed Weight/Kg
20110000000000	POOLSAVER TETRA	Ph & Orp Measurement And Controlling Device	27 x 30 x 13	1,58

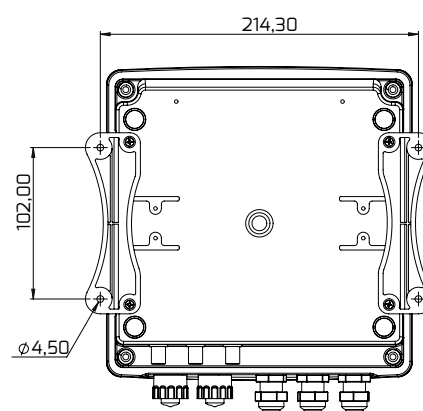
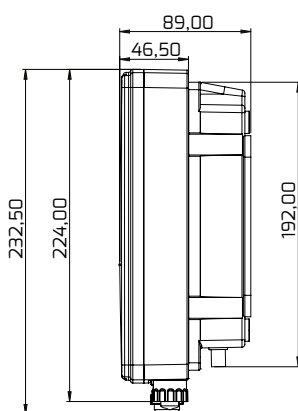
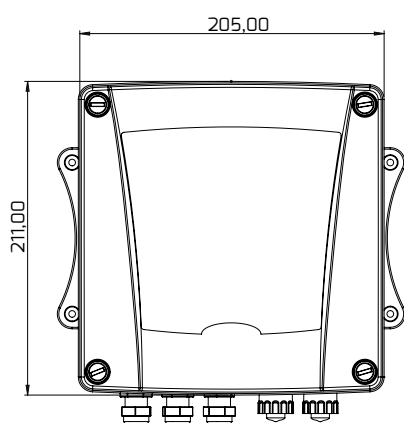



AQUAMETER

Single parameter Measurement and Control Device

- It is a digital pH (0.00 - 14.00) , ORP(0-1000mV), conductivity (0.01 - 20.00 mS) measurement and control device.
- Adjusting rod using buffer liquid, fully digital adjustment without the need for screwdrivers and automatic calibration
- Proportional control
- IP65 plastic body with high resistance to corrosive chemicals
- Analog control outputs (0-10mA, 0-20mA, 4-20mA, 0-5V, 0-10V 2-10V)
- Control direction selections, user password, illuminated LCD display
- Automatic temperature compensation in measurements in pH and conductivity devices
- Programmable alarm output

Stock Code	Model	Description	Package Sizes/cm W-L-H	Packed Weight/Kg
20120000000000	AQUAMETER PH	Ph Measurement And Controlling Device	21 x 24 x 18	1,17
20122000000000	AQUAMETER CON	Conductivity Measurement And Controlling Device	21 x 24 x 18	1,17
20121000000000	AQUAMETER ORP	Orp Measurement And Controlling Device	21 x 24 x 18	1,17

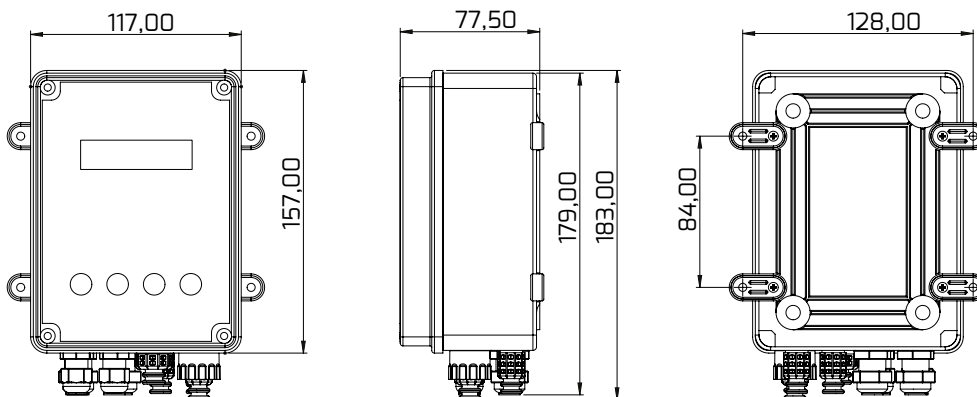



04 Salt Chlorine Generators and Systems

A·nTech
"Water Control Technologies"



Salt Chlorine Generators
and Auxiliary Systems

04 Salt Chlorine Generators

Salt Ionic A Series



SALT IONIC A

Salt Chlorine Generator with Touch-Screen and Manual operation setting

- Easy and flexible operation with touch-screen
- Manual operation and custom production rate setting for Mid-Day
- Production indicator, salt amount indicator and cell operation time indicator
- Filter exit and external exit with Timed function
- Filter tracking, water flow detection, pool cover detection, gas sensor entries
- Water temperature sensor entry
- High efficiency and low energy consumption with bipolar cell technology
- Display and audible warning for Warning / Alarm / Error situations
- Tracking and control on mobile application (Optional)
- Cloud server connection with IOT technology (Optional)



Touchscreen









Wi-fi



Mobile App

Stock Code	Model	gr/h	Package Sizes/cm W-L-H	Packed Weight/Kg
211000120000000	SALT IONIC A 12GR/H	12	44 x 18 x 36	4,85
211000240000000	SALT IONIC A 24GR/H	24	44 x 18 x 36	5,05
211000360000000	SALT IONIC A 36GR/H	36	44 x 18 x 36	5,40

Spare Parts - Options

Stock Code	Stock Name	Description	Included in Package
 211050120000000	SALT IONIC CELL SET 12GR/H	Complete Cell Of Set, Cell Body And Connection Set For 12 Gr/H Models.	✓
 211050240000000	SALT IONIC CELL SET 24GR/H	Complete Cell Of Set, Cell Body And Connection Set For 24 Gr/H Models.	✓
 211050360000000	SALT IONIC CELL SET 36GR/H	Complete Cell Of Set, Cell Body And Connection Set For 36 Gr/H Models.	✓
 211040120000000	SALT IONIC CELL 12GR/H	Inner Cell Plates And Holder For 12 Gr/H Models	✗
 211040240000000	SALT IONIC CELL 24GR/H	Inner Cell Plates And Holder For 24 Gr/H Models	✗
 211040360000000	SALT IONIC CELL 36GR/H	Inner Cell Plates And Holder For 36 Gr/H Models	✗
 600114521001000	SALT IONIC CELL CABLE EXTENSION KIT	Connection Cable Between Cell And Controller.	✗
 410040180000010	ADDITIONAL MODUL SI WIFI	Mobile Supported Communication Module For Salt ionic.	✗



SALT IONIC PH

Salt Chlorine Generator with Touch-Screen, pH Measurement and Control

- Easy and flexible operation with touch-screen
- Manual and operation modes
- Custom productions rate setting for Mid-day when on manual mode
- Automatic operation at suitable pH values with pH measurement
- Production indicator, salt amount indicator and cell operation time indicator Acid
- pump exit connected to the pH measurement
- Filter exit and external exit with Timed function
- Filter tracking, water flow detection, pool cover detection, gas sensor entries
- Acid level entry and water temperature sensor entry
- High efficiency and low energy consumption with bipolar cell technology
- Display and audible warning for Warning / Alarm / Error situations
- Tracking and control on mobile application (Optional)
- Cloud server connection with IOT technology (Optional)



Touchscreen





Wi-fi



Mobile App

Stock Code	Model	gr/h	Package Sizes/cm W-L-H	Packed Weight/Kg
211010120000000	SALT IONIC PH 12GR/H	12	44 x 18 x 36	4,90
211010240000000	SALT IONIC PH 24GR/H	24	44 x 18 x 36	5,10
211010360000000	SALT IONIC PH 36GR/H	36	44 x 18 x 36	5,45

Spare Parts - Options

Stock Code	Stock Name	Description	Included in Package
 211050120000000	SALT IONIC CELL SET 12GR/H	Complete Cell Of Set, Cell Body And Connection Set For 12 Gr/H Models.	✓
 211050240000000	SALT IONIC CELL SET 24GR/H	Complete Cell Of Set, Cell Body And Connection Set For 24 Gr/H Models.	✓
 211050360000000	SALT IONIC CELL SET 36GR/H	Complete Cell Of Set, Cell Body And Connection Set For 36 Gr/H Models.	✓
 211040120000000	SALT IONIC CELL 12GR/H	Inner Cell Plates And Holder For 12 Gr/H Models	✗
 211040240000000	SALT IONIC CELL 24GR/H	Inner Cell Plates And Holder For 24 Gr/H Models	✗
 211040360000000	SALT IONIC CELL 36GR/H	Inner Cell Plates And Holder For 36 Gr/H Models	✗
 600114521001000	SALT IONIC CELL CABLE EXTENSION KIT	Connection Cable Between Cell And Controller.	✗
 410040180000010	ADDITIONAL MODUL SI WIFI	Mobile Supported Communication Module For Salt ionic.	✗

04 Salt Chlorine Generators

Salt Ionic PR Series



SALT IONIC PR

Salt Chlorine Generator with Touch-Screen, pH & ORP Measurement and Control

- Easy and flexible operation with touch-screen
- Manual and automatic operation modes
- Custom production rate setting for Mid-Day when on manual mode
- Automatic operation according to pH and ORP (Redox) measurement
- Production indicator, salt amount indicator and cell operation time indicator
- Acid pump exit connected to the pH measurement
- Filter exit and external exit with Timed function
- Filter tracking, water flow detection, pool cover detection, gas sensor entries
- Acid level entry and water temperature sensor entry
- High efficiency and low energy consumption with bipolar cell technology
- Display and audible warning for Warning / Alarm / Error situations
- Tracking and control on mobile application (Optional)
- Cloud server connection with IOT technology (Optional)



Touchscreen



Wi-fi



Mobile App

Stock Code	Model	gr/h	Package Sizes/cm W-L-H	Packed Weight/Kg
211020120000000	SALT IONIC PR 12GR/H	12	44 x 18 x 36	4,90
211020240000000	SALT IONIC PR 24GR/H	24	44 x 18 x 36	5,10
211020360000000	SALT IONIC PR 36GR/H	36	44 x 18 x 36	5,45

Spare Parts - Options

	Stock Code	Stock Name	Description	Included in Package
	211050120000000	SALT IONIC CELL SET 12GR/H	Complete Cell Of Set, Cell Body And Connection Set For 12 Gr/H Models.	✓
	211050240000000	SALT IONIC CELL SET 24GR/H	Complete Cell Of Set, Cell Body And Connection Set For 24 Gr/H Models.	✓
	211050360000000	SALT IONIC CELL SET 36GR/H	Complete Cell Of Set, Cell Body And Connection Set For 36 Gr/H Models.	✓
	211040120000000	SALT IONIC CELL 12GR/H	Inner Cell Plates And Holder For 12 Gr/H Models	✗
	211040240000000	SALT IONIC CELL 24GR/H	Inner Cell Plates And Holder For 24 Gr/H Models	✗
	211040360000000	SALT IONIC CELL 36GR/H	Inner Cell Plates And Holder For 36 Gr/H Models	✗
	600114521001000	SALT IONIC CELL CABLE EXTENSION KIT	Connection Cable Between Cell And Controller.	✗
	410040180000010	ADDITIONAL MODUL SI WIFI	Mobile Supported Communication Module For Salt ionic.	✗



SALT IONIC ASPH

Touchscreen, with Acid Pumped pH & ORP Measurement and Control, Salt Chlorine Generator

- Easy and flexible operation with touch-screen
- Manual and operation modes
- Custom productions rate setting for Mid-day when on manual mode
- Automatic operation at suitable pH values with pH measurement
- Production indicator, salt amount indicator and cell operation time indicator Acid
- Pump exit connected to the pH measurement
- Water flow detection with internal special design flow switch on the cell
- 2 programmable external relay outputs (for External Chlorine Dosing Pump, Heat Pump, Heater, Pool Lighting, and Waterfall Control options)
- Programmable pool pump-filtration control with Timed function
- On-off control of production with an external input from outside
- Filter tracking, water flow detection, pool cover detection, gas sensor entries
- Acid level entry and water temperature sensor entry
- High efficiency and low energy consumption with bipolar cell technology
- 10.000 hours cell lifespan
- Display and audible warning for Warning / Alarm / Error situations
- Tracking and control on mobile application (Optional)
- Cloud server connection with IOT technology (Optional)
- Internal in 1 pc oem acid dosing pump 2.8L/3B



Touchscreen













Wi-fi



Mobile App

Stock Code	Model	gr/h	Package Sizes/cm W-L-H	Packed Weight/Kg
211010120020000	SALT IONIC ASPH 12GR/H	12	44 x 18 x 36	4,90
211010240020000	SALT IONIC ASPH 24GR/H	24	44 x 18 x 36	5,10
211010360020000	SALT IONIC ASPH 36GR/H	36	44 x 18 x 36	5,45

Spare Parts - Options

Stock Code	Stock Name	Description	Included in Package
 410150023200001	PROBE HOLDER SET P 2 S	Electrode Ph 1m Sensor Xs Single Electrode Housing Filtered + Connection Kit Flow Cell + Ph Calibration Liquid	✗
 410150023300001	PROBE HOLDER SET P 3 S	Electrode Ph 6m Sensor Xs + Electrode fixing gland 1/2-12mm Pp + Ph Calibration Liquid	✗
 211050120000000	SALT IONIC CELL SET 12GR/H	Electrode Ph 1m E + Single Electrode Housing Filtered + Connection Kit Flow Cell + Ph Calibration Liquid	✓
 211050240000000	SALT IONIC CELL SET 24GR/H	Electrode Ph 6m E + Electrode Fixing Gland 1/2-12mm Pp + Ph Calibration Liquid	✓
 211050360000000	SALT IONIC CELL SET 36GR/H	Inner Cell Plates And Holder For 12 Gr/H Models	✓
 211040120000000	SALT IONIC CELL 12GR/H	Inner Cell Plates And Holder For 24 Gr/H Models	✗
 211040240000000	SALT IONIC CELL 24GR/H	Inner Cell Plates And Holder For 36 Gr/H Models	✗
 211040360000000	SALT IONIC CELL 36GR/H	Connection Cable Between Cell And Controller.	✗
 410040180000010	ADDITIONAL MODUL SI WIFI	Mobile Supported Communication Module For Salt Ionic.	✗
 6005210100100	YP ASPENDOSE OEM 2,8L/3B 24VDC	Built In Oem Peristaltic Pump For Salt Ionic Asph	✓

04 Salt Chlorine Generators

Salt Ionic PR Series



SALT IONIC ASPR

Touchscreen, with Acid Pumped pH & ORP Measurement and Control, Salt Chlorine Generator

- Easy and flexible operation with touch-screen
- Manual and operation modes
- Custom productions rate setting for Mid-day when on manual mode
- Automatic operation at suitable pH values with pH measurement
- Production indicator, salt amount indicator and cell operation time indicator Acid
- pump exit connected to the pH measurement
- Flow switch with internal custom-designed flow sensor for water flow detection on the cell
- 2 programmable external relay outputs
(External chlorine dosing pump - Heat pump - Heater)
- Ability to provide pool lighting and waterfall control options
- Programmable pool pump-filtration control with Timed function
- On-off control of production with an external input from outside
- Filter tracking, water flow detection, pool cover detection, gas sensor entries
- Acid level entry and water temperature sensor entry
- High efficiency and low energy consumption with bipolar cell technology
- 10.000 hours cell lifespan
- Display and audible warning for Warning / Alarm / Error situations
- Tracking and control on mobile application (Optional)
- Cloud server connection with IOT technology (Optional)
- Internal in 1 pc oem acid Dosing Pump 2.8L/3B



Touchscreen



Wi-fi



Mobile App

Stock Code

Model











gr/h

Package Sizes/cm
W-L-H

Packed
Weight/Kg

211020120020000	SALT IONIC ASPR 12GR/H	12	44 x 18 x 36	4,90
211020240020000	SALT IONIC ASPR 24GR/H	24	44 x 18 x 36	5,10
211020360020000	SALT IONIC ASPR 36GR/H	36	44 x 18 x 36	5,45

Spare Parts - Options

Stock Code	Stock Name	Description	Included in Package
 410150023200001	PROBE HOLDER SET P 2 S	Electrode Ph 1m Sensor Xs Single Electrode Housing Filtered + Connection Kit Flow Cell + Ph Calibration Liquid	✗
 410150023300001	PROBE HOLDER SET P 3 S	Electrode Ph 6m Sensor Xs + Electrodefixing gland 1/2-12mmpp + Ph Calibration Liquid	✗
 211050120000000	SALT IONIC CELL SET 12GR/H	Electrode Ph 1m E + Single Electrode Housing Filtered + Connection Kit Flow Cell + Ph Calibration Liquid	✓
 211050240000000	SALT IONIC CELL SET 24GR/H	Electrode Ph 6m E + Electrode Fixing Gland 1/2-12mm Pp + Ph Calibration Liquid	✓
 211050360000000	SALT IONIC CELL SET 36GR/H	Inner Cell Plates And Holder For 12 Gr/H Models	✓
 211040120000000	SALT IONIC CELL 12GR/H	Inner Cell Plates And Holder For 24 Gr/H Models	✗
 211040240000000	SALT IONIC CELL 24GR/H	Inner Cell Plates And Holder For 36 Gr/H Models	✗
 211040360000000	SALT IONIC CELL 36GR/H	Connection Cable Between Cell And Controller.	✗
 410040180000010	ADDITIONAL MODUL SI WIFI	Mobile Supported Communication Module For Salt Ionic.	✗
 600521010100100	YP ASPENDOSE OEM 2.8L/3B 24VDC	Built In Oem Peristaltic Pump For Salt Ionic Asph	✓

SALT IONIC TECHNICAL SPECIFICATIONS

	SALT IONIC 12	SALT IONIC 24	SALT IONIC 36
Production Capacity	12 gr/hour	24 gr/hour	36 gr/hour
Cell Current	2.4A	4.8A	7.2A
Cell Voltage	25	25	25
Power	60 W	120 W	180 W
Supply	190-240V AC 47 ~ 63Hz		
Rated Current	1.2A	1.7A	2.2A
Need for Salt	4gr/l		
User Interface	320x240 65K Color TFT Resistive Touchscreen		

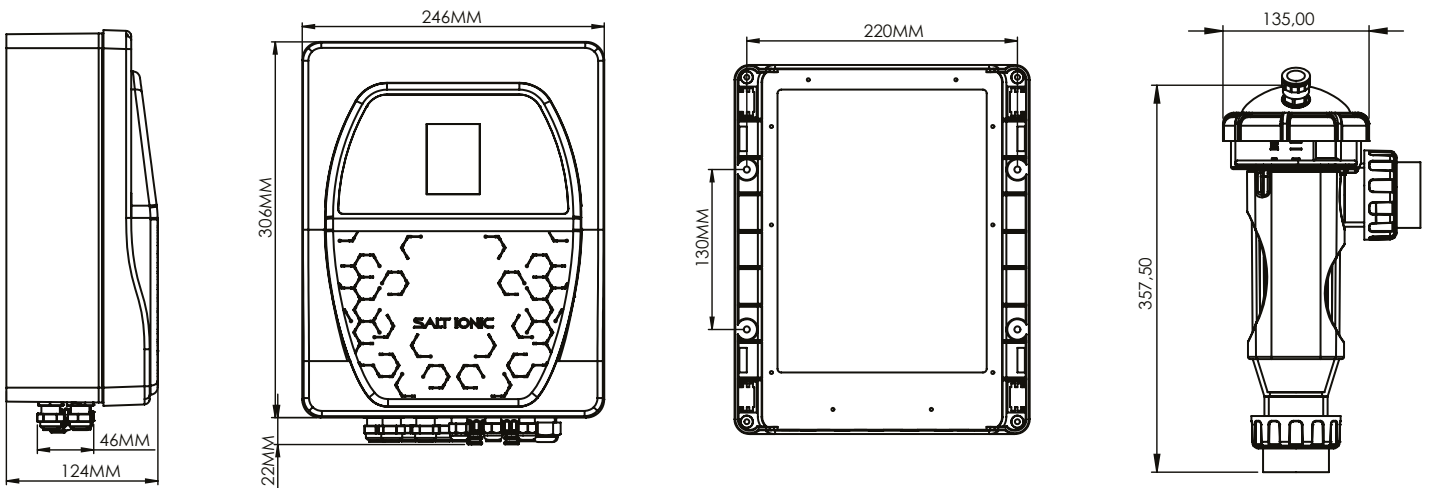

SALT IONIC SAMPLE WIRING DIAGRAM ONLY

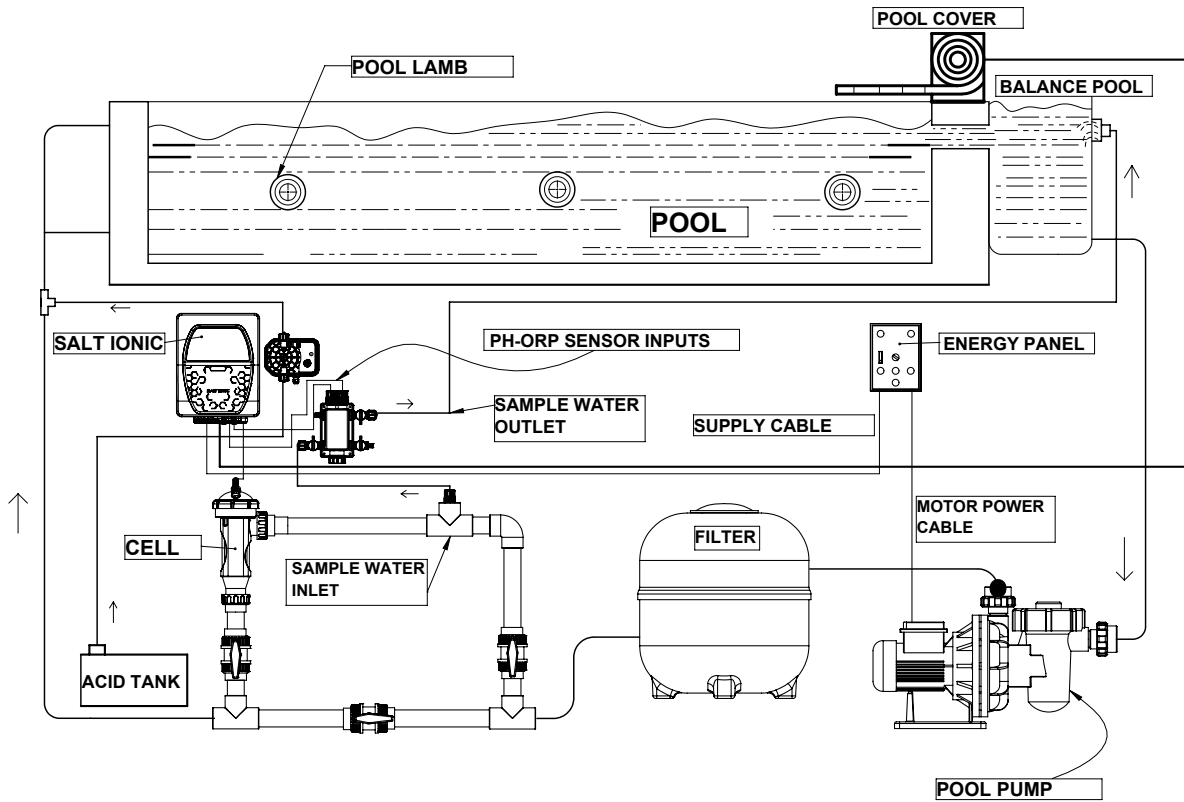

SALT IONIC **A**

12GR/H

Code	Description
A	Salt Chlorine Generator with Touch-Screen and Manual operation setting
PH	Salt Chlorine Generator with Touch-Screen, pH Measurement and Control
PR	Salt Chlorine Generator with Touch-Screen, pH & ORP Measurement and Control
ASPH	Touchscreen, with Acid Pumped pH & ORP Measurement and Control, SaltChlorine Generator
ASPR	Touchscreen, with Acid Pumped pH & ORP Measurement and Control, Salt Chlorine Generator

Code	Description
12GR/H	It can produce 12g per hour while operating at maximum rate.
24GR/H	It can produce 24g per hour while operating at maximum rate.
36GR/H	It can produce 36g per hour while operating at maximum rate.











SYSTEM I2

Auxiliary System with pH measurement for Manual Salt Chlorine Generator

- Connection elements mounted on 50x75 panel
- 1 x Aspendose PR (ph controlled) Dosing Pump
- Single-entry electrode housing cell with filter and connection parts
- Calibration liquid and calibration stand
- pH electrode

Stock Code	Model	Description	Package Sizes/cm W-L-H	Packed Weight/Kg
431001090302700	SYSTEM I2	Ph Measurement And Dosing System. For Salt Chlorine Generators Without Ph Measurement	78 x 54 x 19	5,25

Spare Parts - Options

Stock Code	Stock Name	Description	Included in Package
 341025030100000	ASPENDOSE PR 2,5L/3B A ACFAT	Ph/Orp Measurement And Controlled Digital Peristaltic Dosing Pump	✓
 421000010150010	ELECTRODE PH 1M SENSOR X5	Combined Ph Electrode With 1 Meter Cable And Bnc Connector	✓
 600112510010000	ELECTRODE HOUSING SET 1	Flow Cell With Single inputs For 12 mm Sensors.	✓
 600110400100010	MOUNTING SET FOR SYSTEM 2	Connection Parts For Electrode Housing.	✓
 429900000040020	CALIBRATION LIQUID PH 4 20ML	Ph 4 20ML Calibration Liquid	✓
 429900000070020	CALIBRATION LIQUID PH 7 20ML	Ph 7 20ML Calibration Liquid	✓
 410110030000000	LIQUOID LEVEL SET FOR SUCTION LINE PP	Dosing Pump Liquid Level Sensor Set	✓
 600112551000000	ELECTRODE HOUSING FLOW MODULE	Sample Water Flow Control Module With Signal Output, Valve. (Clamp Connected)	✗
 600112572000000	ELECTRODE HOUSING CLIP SET	4 Clips And 1 Each Of Open And Close Couplings To Join The Housing.	✗

04 Salt Chlorine Generator Systems

System I3



SYSTEM I3

Auxiliary System for Salt Chlorine Generator with pH Measurement

- Connection elements mounted on 50x75 panel
- 1pc 2.8 L/3B Aspendose A Peristaltic Dosing Pump
- Single-entry electrode housing cell with filter and connection parts
- Calibration liquid and calibration stand
- pH electrode

Stock Code	Model	Description	Package Sizes/cm W-L-H	Packed Weight/Kg
431001090302500	SYSTEM I3	Ph Dosing System For Ph Measured Salt Chlorine Generators	44 x 18 x 36	3,50

Spare Parts - Options

	Stock Code	Stock Name	Description	Included in Package
	340028030101000	ASPENDOSE A 2,8L/3B A 220AT	2,8 Lt/H 3 Bar Analog Peristaltic Dosing Pump	✓
	421000010150010	ELECTRODE PH 1M SENSOR XS	Combined Ph Electrode With 1 Meter Cable And Bnc Connector	✓
	600112510010000	ELECTRODE HOUSING SET 1	Flow Cell With Single inputs For 12 mm Sensors.	✓
	600110400100010	MOUNTING SET FOR SYSTEM 2	Connection Parts For Electrode Housing.	✓
	429900000040020	CALIBRATION LIQUID PH 4 20ML	Ph 4 20ML Calibration Liquid	✓
	429900000070020	CALIBRATION LIQUID PH 7 20ML	Ph 7 20ML Calibration Liquid	✓
	410110030000000	LIQUOID LEVEL SET PP	Dosing Pump Liquid Level Sensor Set	✗
	600112551000000	ELECTRODE HOUSING FLOW MODULE	Sample Water Flow Control Module With Signal Output, Valve. (Clamp Connected)	✗
	600112572000000	ELECTRODE HOUSING CLIP SET	4 Clips And 1 Each Of Open And Close Couplings To Join The Housing.	✗





SYSTEM I4

Auxiliary system with pH measurement for Manual Salt Chlorine Generator

- Connection elements mounted on 50x75 panel
- 1pc Aspendoe PR (with pH control) Dosing Pump
- Single-entry electrode housing cell with filter and connection parts
- Calibration liquid and calibration stand
- pH electrode

Stock Code	Model	Description	Package Sizes/cm W-L-H	Packed Weight/Kg
431001090301400	SYSTEM I4	Ph Dosing System For Ph & Orp Measured Salt Chlorine Generators	78 x 54 x 19	5,25

Spare Parts - Options

Stock Code	Stock Name	Description	Included in Package
 340028030101000	ASPENDOSE A 2.8L/3B A 220AT	2.8 Lt/H 3 Bar Analog Peristaltic Dosing Pump	✓
 421000010150010	ELECTRODE PH 1M SENSOR XS	Combined Ph Electrode With 1 Meter Cable And Bnc Connector	✓
 421000110100030	ELECTRODE ORP 1M SENSOR XS	Combined Orp Electrode With 1 Meter Cable And Bnc Connector	✓
 600112520011000	ELECTRODE HOUSING SET 2 NO FILTER	Electrode Housing With Dual inputs For 12 mm Sensors.	✓
 600110400100010	MOUNTING SET FOR SYSTEM 2	Connection Parts For Electrode Housing.	✓
 429900000040020	CALIBRATION LIQUID PH 4 20ML	Ph 4 20ML Calibration Liquid	✓
 429900000070020	CALIBRATION LIQUID PH 7 20ML	Ph 7 20ML Calibration Liquid	✓
 429901004750020	CALIBRATION LIQUID ORP 475 20ML	Orp 475 20ML Calibration Liquid	✓
 410110030000000	LIQUOID LEVEL SET PP	Dosing Pump Liquid Level Sensor Set	✗
 600112551000000	ELECTRODE HOUSING FLOW MODULE	Sample Water Flow Control Module With Signal Output, Valve. (Clamp Connected)	✗
 600112572000000	ELECTRODE HOUSING CLIP SET	4 Clips And 1 Each Of Open And Close Couplings To Join The Housing.	✗

04 Salt Chlorine Generator Systems

System I5











SYSTEM I5

Auxiliary System for Salt Chlorine Generator with pH Measurement

- Connection elements mounted on 50x75 panel
- 1pc 5L/10B Optima Dosing Pump
- Single-entry electrode housing cell with filter and connection parts
- Calibration liquid and calibration stand
- pH electrode

Stock Code	Model	Description	Package Sizes/cm W-L-H	Packed Weight/Kg
431001090102100	SYSTEM I5	Ph Dosing System For Ph Measured Salt Chlorine Generators	78 X 54 X 19	6.68

Spare Parts - Options

Stock Code	Stock Name	Description	Included in Package
 307105010101000 DP OPTIMA A 5L/10B V220FAT	DP OPTIMA A 5L/10B V220FAT	5L/10B PvdF Headanalog Dosing Pump	✓
 421000010150010 ELECTRODE PH 1M SENSOR XS	ELECTRODE PH 1M SENSOR XS	Combined Ph Electrode With 1 Meter Cable And Bnc Connector	✓
 600112510010000 ELECTRODE HOUSING SET 1	ELECTRODE HOUSING SET 1	Flow Cell With Single inputs For 12 mm Sensors.	✓
 600110400100010 MOUNTING SET FOR SYSTEM 2	MOUNTING SET FOR SYSTEM 2	Connection Parts For Electrode Housing.	✓
 429900000040020 CALIBRATION LIQUID PH 4 20ML	CALIBRATION LIQUID PH 4 20ML	Ph 4 20ML Calibration Liquid	✓
 429900000070020 CALIBRATION LIQUID PH 7 20ML	CALIBRATION LIQUID PH 7 20ML	Ph 7 20ML Calibration Liquid	✓
 410110030000000 LIQUID LEVEL SET PP	LIQUID LEVEL SET PP	Dosing Pump Liquid Level Sensor Set	✗
 600112510000000 ELECTRODE HOUSING FLOW MODULE	ELECTRODE HOUSING FLOW MODULE	Sample Water Flow Control Module With Signal Output, Valve. (Clamp Connected)	✗
 600112572000000 ELECTRODE HOUSING CLIP SET	ELECTRODE HOUSING CLIP SET	4 Clips And 1 Each Of Open And Close Couplings To Join The Housing.	✗









SYSTEM I6

Auxiliary System for Salt Chlorine Generator with pH and ORP Measurement

- Connection elements mounted on 50x75 panel
- 1pc 5L/10B Optima Dosing Pump
- Double-entry electrode housing cell and connection parts
- Calibration liquid and calibration stand
- pH and ORP electrode

Stock Code	Model	Description	Package Sizes/cm W-L-H	Packed Weight/Kg
431001090102200	SYSTEM I6	Ph Dosing System For Ph & Orp Measured Salt Chlorine Generators	78 x 54 x 19	6,82

Spare Parts - Options

Stock Code	Stock Name	Description	Included in Package
 307105010101000	DP OPTIMA A 5L/10B V220FAT	5L/10B PvdF Head Analog Dosing Pump	✓
 421000010150010	ELECTRODE PH 1M SENSOR XS	Combined Ph Electrode With 1 Meter Cable And Bnc Connector	✓
 421000110100030	ELECTRODE ORP 1M SENSOR XS	Combined Orp Electrode With 1 Meter Cable And Bnc Connector	✓
 600112520011000	ELECTRODE HOUSING SET 2 NO FILTER	Electrode Housing With Dual inputs For 12 mm Sensors.	✓
 600110400100010	MOUNTING SET FOR SYSTEM 2	Connection Parts For Electrode Housing.	✓
 429900000040020	CALIBRATION LIQUID PH 4 20ML	Ph 4 20ML Calibration Liquid	✓
 429900000070020	CALIBRATION LIQUID PH 7 20ML	Ph 7 20ML Calibration Liquid	✓
 429901004750020	CALIBRATION LIQUID ORP 475 20ML	Orp 475 20ML Calibration Liquid	✓
 410110030000000	LIQUID LEVEL SET PP	Dosing Pump Liquid Level Sensor Set	✗
 600112551000000	ELECTRODE HOUSING FLOW MODULE	Sample Water Flow Control Module With Signal Output, Valve. (Clamp Connected)	✗
 600112572000000	ELECTRODE HOUSING CLIP SET	4 Clips And 1 Each Of Open And Close Couplings To Join The Housing.	✗

04 Salt Chlorine Generator Systems

System I8

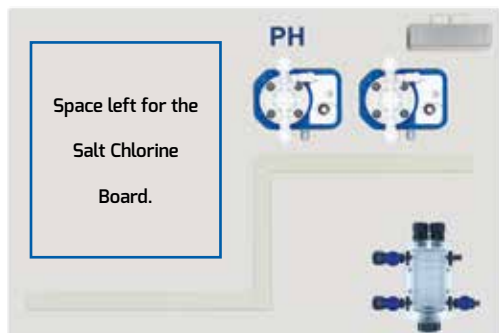











SYSTEM I8

Auxiliary System for Salt Chlorine Generator with pH and ORP Measurement

- Connection elements mounted on 60x90 panel
- 2 x 5L/10b Optima Dosing Pump
- Dirt trap pre-filter
- Electrode flow cell
- Inlet-outlet records (6x8 mm) and sampling valve
- Calibration liquids and calibration stand
- pH electrode and ORP electrode

Stock Code	Model	Description	Package Sizes/cm W-L-H	Packed Weight/Kg
431001090102600	SYSTEM I8	Ph And Additional Dosing System For Salt Chlorine Generators With Ph&Orp Measurement	96 x 66 x 16	9,90

Spare Parts - Options

Stock Code	Stock Name	Description	Included in Package
 307105010101000	DP OPTIMA A 5L/10B V220FAT	5L/10B PvdF Head Analog Dosing Pump	✓
 421000010150010	ELECTRODE PH 1M SENSOR XS	Combined Ph Electrode With 1 Meter Cable And Bnc Connector	✓
 421000110100030	ELECTRODE ORP 1M SENSOR XS	Combined Orp Electrode With 1 Meter Cable And Bnc Connector	✓
 600112520011000	ELECTRODE HOUSING SET 2 NO FILTER	Electrode Housing With Dual inputs For 12 mm Sensors.	✓
 600110400100010	MOUNTING SET FOR SYSTEM 2	Connection Parts For Electrode Housing.	✓
 429900000040020	CALIBRATION LIQUID PH 4 20ML	Ph 4 20ML Calibration Liquid	✓
 429900000070020	CALIBRATION LIQUID PH 7 20ML	Ph 7 20ML Calibration Liquid	✓
 429901004750020	CALIBRATION LIQUID ORP 475 20ML	Orp 475 20ML Calibration Liquid	✓
 410110030000000	LIQUOID LEVEL SET PP	Dosing Pump Liquid Level Sensor Set	✗
 600112551000000	ELECTRODE HOUSING FLOW MODULE	Sample Water Flow Control Module With Signal Output, Valve. (Clamp Connected)	✗
 600112572000000	ELECTRODE HOUSING CLIP SET	4 Clips And 1 Each Of Open And Close Couplings To Join The Housing.	✗



05 Systems

Time and convenience for re-preparation of process water are among the priorities of the applicator. At this point, ready packs and systems are one step ahead in terms of time saving and convenience during the application. AnTech combines the models of its product family for easy and quick mounting and provides you with ready packs. The group of AnTech Systems is composed of the Measuring and Controlling Device mounted on the panel, Dosing Pumps, Sensors, Sample Flow Cells, Calibration Liquids, Calibration Stand, Basic User Manual and Installation Kits.

Our AnTech experts provide the most appropriate ready packs for standard applications and develop customized packs for your specific applications.



Systems











SYSTEM 05

Optima Pumped Pool Control System with pH&ORP Measurement

- All connection components mounted on 50x75 panel
- Poolsaver Tetra
- 2 level sensor inputs, 1 flow switch input
- 2pcs 5L/10B Optima A Dosing Pump
- Double input electrode housing cell
- Calibration liquids and calibration stand
- pH and ORP electrode
- (pH and ORP electrodes are model E at SYSTEM 05 E.)

Stock Code	Model	Description	Package Sizes/cm W-L-H	Packed Weight/Kg
103441841815200	SYSTEM 05	Ph&Orp Measurement System With 5L/10B Dosing Pump	78 x 54 x 19	11,40
103441841815000	SYSTEM 05 E	Ph&Orp Measurement System With 5L/10B Dosing Pump	78 x 54 x 19	11,40

Spare Parts - Options

Stock Code	Stock Name	Description	Included in Package
 2011000000000000	POOLSAVER TETRA	Ph & Orp Measurement And Controlling Device. For All Models	✓
 307105010101000	DP OPTIMA A 5L/10B V220FAT	5L/10B PvdF Head Analog Dosing Pump (2Pcs). For All Models	✓
 421000010150010	ELECTRODE PH 1M SENSOR XS	Combined Ph Electrode With 1 Meter Cable And Bnc Connector	✓
 421000110100030	ELECTRODE ORP 1M SENSOR XS	Combined Orp Electrode With 1 Meter Cable And Bnc Connector	✓
 421000000100010	ELECTRODE PH 1MT E	Combined Ph Electrode With 1 Meter Cable And Bnc Connector. For E Models	✓
 421000100100010	ELECTRODE ORP 1M E	Combined Orp Electrode With 1 Meter Cable And Bnc Connector. For E Models	✓
 600112520011000	ELECTRODE HOUSING SET 2 NO FILTER	Electrode Housing With Dual inputs For 12 mm Sensors.	✓
 600110400100010	MOUNTING SET FOR SYSTEM 2	Connection Sets for Electrode Housings	✓
 410110030000000	LIQUOID LEVEL SET PP	Dosing Pump Liquid Level Sensor Set PP. For All Models	✗
 600112551000000	ELECTRODE HOUSING FLOW MODULE	Sample Water Flow Control Module With Signal Output. Valve. (Clamp Connected) For All Models	✗
 600112572000000	ELECTRODE HOUSING CLIP SET	4 Clips And 1 Each Of Open And Close Couplings To Join The Housing. For All Models	✗













SYSTEM 04

Lara Pumped Pool Control System with pH&ORP Measurement

- All connection components mounted on 50x75 panel
- Poolsaver Tetra
- 2 level sensor inputs, 1 flow switch input
- 2pcs 5L/7B Lara A Dosing Pump
- Double input electrode housing cell
- Calibration liquids and calibration stand
- pH and ORP electrode
- (In SYSTEM 04 E, pH and ORP electrodes are model E.)

Stock Code	Model	Description	Package Sizes/cm W-L-H	Packed Weight/Kg
103411411415200	SYSTEM 04	Ph&Orp Measurement System With 5L/7B Dosing Pump	78 x 54 x 19	11,40
103411411415000	SYSTEM 04 E	Ph&Orp Measurement System With 5L/7B Dosing Pump	78 x 54 x 19	11,40

Spare Parts - Options

Stock Code	Stock Name	Description	Included in Package
 2011000000000000	POOLSAVER TETRA	Ph & Orp Measurement And Controlling Device. For All Models	✓
 301105007101000	DP LARA A 5L/7B V220FAT	5L/7B Pvdf Head Analog Dosing Pump (2Pcs) For All Models	✓
 421000010150010	ELECTRODE PH 1M SENSOR XS	Combined Ph Electrode With 1 Meter Cable And Bnc Connector	✓
 421000110100030	ELECTRODE ORP 1M SENSOR XS	Combined Orp Electrode With 1 Meter Cable And Bnc Connector	✓
 421000000100010	ELECTRODE PH 1MT E	Combined Ph Electrode With 1 Meter Cable And Bnc Connector, For E Models	✓
 421000100100010	ELECTRODE ORP 1M E	Combined Orp Electrode With 1 Meter Cable And Bnc Connector, For E Models	✓
 600112520011000	ELECTRODE HOUSING SET 2 NO FILTER	Electrode Housing With Dual inputs For 12 mm Sensors. For All Models.	✓
 600110400100010	MOUNTING SET FOR SYSTEM 2	Connection Sets for Electrode Housings	✓
 410110030000000	LIQUID LEVEL SET PP	Dosing Pump Liquid Level Sensor Set. For All Models.	✗
 600112551000000	ELECTRODE HOUSING FLOW MODULE	Sample Water Flow Control Module With Signal Output, Valve. (Clamp Connected) For All Models	✗
 600112572000000	ELECTRODE HOUSING CLIP SET	4 Clips And 1 Each Of Open And Close Couplings To Join The Housing. For All Models	✗









SYSTEM 03

pH&ORP Measured Nano pumped Pool Control System

- All connection components mounted on 45x60 panel
- Poolsaver Tetra
- 2 level sensor inputs, 1 flow switch input
- 2pcs 5L/5B Nano A Dosing Pump
- Double input electrode housing cell
- Calibration liquids and calibration stand
- pH and ORP electrode
- (pH and ORP electrodes are model E at SYSTEM 03 E.)

Stock Code	Model	Description	Package Sizes/cm W-L-H	Packed Weight/Kg
102131331315200	SYSTEM 03	Ph&Orp Measurement System With 5L/5B Dosing Pump	65 x 51 x 16	8,40
102131331315000	SYSTEM 03 E	Ph & Orp Measurement System With 5L/5B Dosing Pump	65 x 51 x 16	8,40

Spare Parts - Options

Stock Code	Stock Name	Description	Included in Package
 2011000000000000	POOLSAVER TETRA	Ph & Orp Measurement And Controlling Device. For All Models	✓
 302105005101000	DP NANO A 5L/5B V220FAT	5L/5B Pp Head Analog Dosing Pump (2Pcs). For All Models	✓
 421000010150010	ELECTRODE PH 1M SENSOR XS	Combined Ph Electrode With 1 Meter Cable And Bnc Connector	✓
 421000110100030	ELECTRODE ORP 1M SENSOR XS	Combined Orp Electrode With 1 Meter Cable And Bnc Connector	✓
 421000000100010	ELECTRODE PH 1M E	Combined Ph Electrode With 1 Meter Cable And Bnc Connector. For E Models	✓
 421000100100010	ELECTRODE ORP 1M E	Combined Orp Electrode With 1 Meter Cable And Bnc Connector. For E Models	✓
 600112520011000	ELECTRODE HOUSING SET 2 NO FILTER	Electrode Housing With Dual inputs For 12 mm Sensors. For All Models.	✓
 600110400100010	MOUNTING SET FOR SYSTEM 2	Connection Sets for Electrode Housings	✓
 410110030000000	LIQUOID LEVEL SET PP	Dosing Pump Liquid Level Sensor Set. For All Models.	✗
 600112551000000	ELECTRODE HOUSING FLOW MODULE	Sample Water Flow Control Module With Signal Output. Valve. (Clamp Connected) For All Models	✗
 600112572000000	ELECTRODE HOUSING CLIP SET	4 Clips And 1 Each Of Open And Close Couplings To Join The Housing. For All Models	✗



SYSTEM AQUATIC

Peristaltic Pump Pool Control System with pH&ORP Measurement

- All connection components mounted on 45x60 panel
- AQUATIC 5.1L/0.5B or AQUATIC 2,8L/3B option
- 2 level sensor inputs, 1 flow switch input
- Double input electrode housing cell
- Calibration liquids and calibration stand
- pH and ORP electrode
- (The pH and ORP electrodes in the SYSTEM Aquatic E are model E.)

Stock Code	Model	Description	Package Sizes/cm W-L-H	Packed Weight/Kg
105160152000000	SYSTEM AQUATIC 2,8L/3B	Ph & Orp Measurement System With 2,8L/3B Dosing Pump	65 x 51 x 16	6,70
105160150000000	SYSTEM AQUATIC 2,8L/3B E	Ph & Orp Measurement System With 2,8L/3B Dosing Pump "E"	65 x 51 x 16	6,70

Spare Parts - Options

	Stock Code	Stock Name	Description	Included in Package
	201312000000000	AQUATIC 220 2,8L/3B R	Ph & Orp Measuring, Controlling, And Dosing Device	✓
	421000010150010	ELECTRODE PH 1M SENSOR XS	Combined Ph Electrode With 1 Meter Cable And Bnc Connector	✓
	421000110100030	ELECTRODE ORP 1M SENSOR XS	Combined Orp Electrode With 1 Meter Cable And Bnc Connector	✓
	421000000100010	ELECTRODE PH 1MT E	Combined Ph Electrode With 1 Meter Cable And Bnc Connector, For E Models	✓
	421000100100010	ELECTRODE ORP 1M E	Combined Orp Electrode With 1 Meter Cable And Bnc Connector, For E Models	✓
	600112520011000	ELECTRODE HOUSING SET 2 NO FILTER	Electrode Housing With Dual inputs For 12 mm Sensors. For All Models.	✓
	600110400100010	MOUNTING SET FOR SYSTEM 2	Connection Sets for Electrode Housings	✓
	410110030000000	LIQUOID LEVEL SET PP	Dosing Pump Liquid Level Sensor Set. For All Models.	✗
	600112551000000	ELECTRODE HOUSING FLOW MODULE	Sample Water Flow Control Module With Signal Output, Valve. (Clamp Connected) For All Models	✗
	600112572000000	ELECTRODE HOUSING CLIP SET	4 Clips And 1 Each Of Open And Close Couplings To Join The Housing. For All Models	✗











SYSTEM 02

pH&ORP Measured Pool Control System

- All connection components mounted on 60x90 panel
- Poolsaver Tetra with measuring and control device
- 2 level sensor inputs, 1 flow switch input
- Dirt trap pre-filter
- Electrode flow cell
- Inlet-outlet records (6x8 mm) and sampling valve
- Calibration liquids and calibration stand
- pH and ORP electrode
(pH and ORP electrodes in SYSTEM 02 E are E model.)

Stock Code	Model	Description	Package Sizes/cm W-L-H	Packed Weight/Kg
102200000020200	SYSTEM 02	Ph & Orp Measurement System	96 x 66 x 16	6,85
102200000020000	SYSTEM 02 E	Ph & Orp Measurement System	96 x 66 x 16	6,85

Spare Parts - Options

Stock Code	Stock Name	Description	Included in Package
 201100000000000	POOLSAVER TETRA	Ph & Orp Measurement And Controlling Device. For All Models	✓
 421000010150010	ELECTRODE PH 1M SENSOR XS	Combined Ph Electrode With 1 Meter Cable And Bnc Connector	✓
 421000110100030	ELECTRODE ORP 1M SENSOR XS	Combined Orp Electrode With 1 Meter Cable And Bnc Connector	✓
 421000000100010	ELECTRODE PH 1MT E	Combined Ph Electrode With 1 Meter Cable And Bnc Connector, For E Models	✓
 421000100100010	ELECTRODE ORP 1M E	Combined Orp Electrode With 1 Meter Cable And Bnc Connector, For E Models	✓
 600112520010000	ELECTRODE HOUSING SET 2	Electrode Housing With Dual input For 12 mm Sensors. For All Models,	✓
 600110400100010	MOUNTING SET FOR SYSTEM 2	Connection Sets for Electrode Housings	✓
 410110030000000	LIQUOID LEVEL SET PP	Dosing Pump Liquid Level Sensor Set. For All Models.	✗
 600112551000000	ELECTRODE HOUSING FLOW MODULE	Sample Water Flow Control Module With Signal Output. Valve. (Clamp Connected) For All Models	✗
 600112572000000	ELECTRODE HOUSING CLIP SET	4 Clips And 1 Each Of Open And Close Couplings To Join The Housing. For All Models	✗









SYSTEM 02 DP 450

Lara Pumped Pool Control System with pH&ORP Measurement

- All connection components mounted on 60x90 panel
- Poolsaver Tetra with measuring and control device
- 2pcs DP Lara A 5L/7B V220FAT dosing pump
- 2 level sensor inputs, 1 flow switch input
- Dirt trap pre-filter
- Electrode flow cell
- Inlet-outlet records (6x8 mm) and sampling valve
- Calibration liquids and calibration stand
- pH and ORP electrode
(pH and ORP electrodes are model E in SYSTEM 02 DP 450 E.)

Stock Code	Model	Description	Package Sizes/cm W-L-H	Packed Weight/Kg
102211411420200	SYSTEM 02 DP 450	Ph & Orp Measurement System With 2X Lara A 5L/7B Dosing Pump	96 x 66 x 16	11,95
102211411420000	SYSTEM 02 DP 450 E	Ph & Orp Measurement System With 2X Lara A 5L/7B Dosing Pump	96 x 66 x 16	11,95

Spare Parts - Options

Stock Code	Stock Name	Description	Included in Package
 2011000000000000	POOLSAVER TETRA	Ph & Orp Measurement And Controlling Device. For All Models	✓
 301105007101000	DP LARA A 5L/7B V220FAT	5L/7B Pvdf Head Analog Dosing Pump (2Pcs). For All Models	✓
 421000010150010	ELECTRODE PH 1M SENSOR XS	Combined Ph Electrode With 1 Meter Cable And Bnc Connector	✓
 421000110100030	ELECTRODE ORP 1M SENSOR XS	Combined Orp Electrode With 1 Meter Cable And Bnc Connector	✓
 421000000100010	ELECTRODE PH 1MT E	Combined Ph Electrode With 1 Meter Cable And Bnc Connector. For E Models	✓
 421000100100010	ELECTRODE ORP 1M E	Combined Orp Electrode With 1 Meter Cable And Bnc Connector. For E Models	✓
 600112520010000	ELECTRODE HOUSING SET 2	Electrode Housing With Dual input, Dirt Trap Pre Filter-Ed For 12 mm Sensors. For All Models.	✓
 600110400100010	MOUNTING SET FOR SYSTEM 2	Connection Sets for Electrode Housings	✓
 410110030000000	LIQUOID LEVEL SET PP	Dosing Pump Liquid Level Sensor Set. For All Models.	✗
 600112551000000	ELECTRODE HOUSING FLOW MODULE	Sample Water Flow Control Module With Signal Output. Valve. (Clamp Connected) For All Models	✗
 600112572000000	ELECTRODE HOUSING CLIP SET	4 Clips And 1 Each Of Open And Close Couplings To Join The Housing. For All Models	✗



SYSTEM 02 DP 750

pH&ORP Measured Pool Control System with Lara Pump

- All connection components mounted on 60x90 panel
- Poolsaver Tetra with measuring and control device
- 2pcs DP Lara A 10L/5B V220FAT dosing pump
- 2 level sensor inputs, 1 flow switch input
- Dirt trap pre-filter
- Electrode flow cell
- Inlet-outlet records (6x8 mm) and sampling valve
- Calibration liquids and calibration stand
- pH and ORP electrode
(pH and ORP electrodes are model E at SYSTEM 02 DP 750 E.)

Stock Code	Model	Description	Package Sizes/cm W-L-H	Packed Weight/Kg
102211511520200	SYSTEM 02 DP 750	Ph & Orp Measurement System With 2X Lara A 10Lt/5B Pump	96 x 66 x 16	11,95
102211511520000	SYSTEM 02 DP 750 E	Ph & Orp Measurement System With 2X Lara A 10Lt/5B Pump	96 x 66 x 16	11,95

Spare Parts - Options

Stock Code	Stock Name	Description	Included in Package
 20110000000000 POOLSAVER TETRA	Ph & Orp Measurement And Controlling Device. For All Models	✓	
 301110005101000 DP LARA A 10L/5B V220FAT	10L/5B PvdF Head Analog Dosing Pump (2Pcs) For All Models	✓	
 421000010150010 ELECTRODE PH 1M SENSOR XS	Combined Ph Electrode With 1 Meter Cable And Bnc Connector	✓	
 421000110100030 ELECTRODE ORP 1M SENSOR XS	Combined Orp Electrode With 1 Meter Cable And Bnc Connector	✓	
 421000000100010 ELECTRODE PH 1M E	Combined Ph Electrode With 1 Meter Cable And Bnc Connector, For E Models	✓	
 421000100100010 ELECTRODE ORP 1M E	Combined Orp Electrode With 1 Meter Cable And Bnc Connector, For E Models	✓	
 600112520010000 ELECTRODE HOUSING SET 2	Electrode Housing With Dual input For 12 mm Sensors. For All Models.	✓	
 600110400100010 MOUNTING SET FOR SYSTEM 2	Connection Sets for Electrode Housings	✓	
 410110030000000 LIQUOID LEVEL SET PP	Dosing Pump Liquid Level Sensor Set. For All Models.	✗	
 600112551000000 ELECTRODE HOUSING FLOW MODULE	Sample Water Flow Control Module With Signal Output. Valve. (Clamp Connected) For All Models	✗	
 600112572000000 ELECTRODE HOUSING CLIP SET	4 Clips And 1 Each Of Open And Close Couplings To Join The Housing. For All Models	✗	













SYSTEM 02 DP 1500

Nove Pumped Pool Control System with pH&ORP Measurement

- All connection components mounted on 60x90 panel
- Poolsaver Tetra with measuring and control device
- 2pcs DP Nova A 25L5B VACFAT dosing pumps
- 2 level sensor inputs, 1 flow switch input
- Dirt trap pre-filter
- Electrode flow cell
- Inlet-outlet records (6x8 mm) and sampling valve
- Calibration liquids and calibration stand
- pH and ORP electrode
(pH and ORP electrodes are model E at SYSTEM 02 DP 1500 E.)

Stock Code	Model	Description	Package Sizes/cm W-L-H	Packed Weight/Kg
102221721720200	SYSTEM 02 DP 1500	Ph & Orp Measurement System With 2X Nova A 25L/5B Pump	96 x 66 x 16	13,50
102221721720000	SYSTEM 02 DP 1500 E	Ph & Orp Measurement System With 2X Nova A 25L/5B Pump	96 x 66 x 16	13,50

Spare Parts - Options

Stock Code	Stock Name	Description	Included in Package
 20110000000000000000	POOLSAVER TETRA	Ph & Orp Measurement And Controlling Device. For All Models	✓
 306125005302000	DP NOVA A 25L/5B VACFAT	25L/5B PvdF Head Analog Dosing Pump (2Pcs). For All Models	✓
 421000010150010	ELECTRODE PH 1M SENSOR XS	Combined Ph Electrode With 1 Meter Cable And Bnc Connector	✓
 421000110100030	ELECTRODE ORP 1M SENSOR XS	Combined Orp Electrode With 1 Meter Cable And Bnc Connector	✓
 421000000100010	ELECTRODE PH 1MT E	Combined Ph Electrode With 1 Meter Cable And Bnc Connector, For E Models	✓
 421000100100010	ELECTRODE ORP 1M E	Combined Orp Electrode With 1 Meter Cable And Bnc Connector, For E Models	✓
 600112520010000	ELECTRODE HOUSING SET 2	Electrode Housing With Dual input For 12 mm Sensors. For All Models,	✓
 600110400100010	MOUNTING SET FOR SYSTEM 2	Connection Sets for Electrode Housings	✓
 410110030000000	LIQUID LEVEL SET PP	Dosing Pump Liquid Level Sensor Set. For All Models.	✗
 600112551000000	ELECTRODE HOUSING FLOW MODULE	Sample Water Flow Control Module With Signal Output, Valve. (Clamp Connected) For All Models	✗
 600112572000000	ELECTRODE HOUSING CLIP SET	4 Clips And 1 Each Of Open And Close Couplings To Join The Housing. For All Models	✗











SYSTEM OMNICON PH ORP pH & ORP Measurement and Control System

- All connection components mounted on 60x90 panel
- OmniCon pH ORP
- Dirt trap pre-filter
- Electrode flow cell
- Inlet-outlet records (6x8 mm) and sampling valve
- Calibration liquids and calibration stand
- pH and ORP electrode
- (The pH and ORP electrodes in the SYSTEM Omnicon pH ORP E are model E.)

Stock Code	Model	Description	Package Sizes/cm W-L-H	Packed Weight/Kg
101211000150000	SYSTEM OMNICON PH ORP	Ph & Orp Measurement And Controlling System	96 x 66 x 16	7,05
101211000150001	SYSTEM OMNICON PH ORP E	Ph & Orp Measurement And Controlling System "E"	96 x 66 x 16	7,05

Spare Parts - Options

Stock Code	Stock Name	Description	Included in Package
 201011000000000 OMNICON PH ORP	Ph & Orp Measurement And Controller Device. For All Models	✓	
 421000010150010 ELECTRODE PH 1M SENSOR X5	Combined Ph Electrode With 1 Meter Cable And Bnc Connector	✓	
 421000110100030 ELECTRODE ORP 1M SENSOR X5	Combined Orp Electrode With 1 Meter Cable And Bnc Connector	✓	
 421000000100010 ELECTRODE PH 1MT E	Combined Ph Electrode With 1 Meter Cable And Bnc Connector, For E Models	✓	
 421000100100010 ELECTRODE ORP 1M E	Combined Orp Electrode With 1 Meter Cable And Bnc Connector, For E Models	✓	
 600112520010000 ELECTRODE HOUSING SET 2	Electrode Housing With Dual input Dirt Trap Pre Filter-Ed For 12 mm Sensors. For All Models,	✓	
 600110400100010 MOUNTING SET FOR SYSTEM 2	Connection Sets for Electrode Housings	✓	
 600112551000000 ELECTRODE HOUSING FLOW MODULE	Sample Water Flow Control Module With Signal Output, Valve. (Clamp Connected) For All Models	✗	
 600112572000000 ELECTRODE HOUSING CLIP SET	4 Clips And 1 Each Of Open And Close Couplings To Join The Housing. For All Models	✗	









SYSTEM OMNICON PH FCLp TEMP

pH & Potentiostatic Free Chlorine & Temperature Measurement and Control System

- All connection components mounted on 60x90 panel
- OmniCon pH FCLp Temp
- Dirt trap pre-filter
- Electrode flow cell
- Inlet-outlet records (6x8 mm) and sampling valve
- Calibration liquids and calibration stand
- pH electrode and 0-10 ppm potentiostatic free chlorine electrode
- Temperature sensor

Stock Code	Model	Description	Package Sizes/cm W-L-H	Packed Weight/Kg
101100080100000	SYSTEM OMNICON 1010 PH FCLp TEMP	Ph & Free Chlorine Potentiostatic & Temperature Measurement And Controlling System	96 x 66 x 16	8,35

Spare Parts - Options

	Stock Code	Stock Name	Description	Included in Package
	201014000000000	OMNICON 1010 PH FCLP TEMP	Ph & Free Chlorine Potentiostatic & Temperature Measurement And Controller Device	✓
	421000010150010	ELECTRODE PH 1M SENSOR X5	Combined Ph Electrode With 1 Meter Cable And Bnc Connector	✓
	421002320003010	ELECTRODE POTANSIOSTATIC S8	Potentiostatic Free Chlorine Electrode 0 10 Ppm With S8 Connector	✓
	760204060000007	CABLE SET E COAXIAL SENSOR S8-BNC 1.5 MT	1.5 Meter Cable For Glass Ph Electrode With S8 Connector.	✓
	600112560000000	ELECTRODE HOUSING SET POTENTIOSTATIC	Potentiostatic Electrode Flow Housing Set.	✓
	410270010000000	FLOWREG	Flow Compensator Measurement And Control Kit	✓
	600110400100010	MOUNTING SET FOR SYSTEM 2	Connection Sets for Electrode Housings	✓









SYSTEM OMNICON PH FCL SELECTIVE pH & Free Chlorine Measurement and Control System

- All connection components mounted on 60x90 panel
- OmniCon pH FCL Selective
- Dirt trap pre-filter
- Electrode flow cell
- Inlet-outlet records (6x8 mm) and sampling valve
- Calibration liquids and calibration stand
- pH electrode and 0-5 ppm ion selective free chlorine electrode

Stock Code	Model	Description	Package Sizes/cm W-L-H	Packed Weight/Kg
101210010220000	SYSTEM OMNICON PH FCL SELECTIVE	Ph & Free Chlorine Selective Measurement And Controlling System	96 x 66 x 16	7,55

Spare Parts - Options

Stock Code	Stock Name	Description	Included in Package
 201010080000000 OMNICON PH FCL SELECTIVE	Ph & Free Chlorine Selective Measurement And Controller Device	✓	
 421000010150010 ELECTRODE PH 1M SENSOR XS	Combined Ph Electrode With 1 Meter Cable And Bnc Connector	✓	
 421000320101020 ELECTRODE FCL/0 5 PPM SELECTIVE	Free Chlorine ion Selective Electrode 0 5 Ppm With 1 Meter Cable, Mic Connector.	✓	
 600112510050000 ELECTRODE HOUSING SET 1-15L	Flow Cell With Dual input And Dirt Trap Pre Filter-Ed. For 12 mm Sensors And ion Selective Sensors.	✓	
 600110400100010 MOUNTING SET FOR SYSTEM 2	Connection Sets for Electrode Housings	✓	
 600112551000000 ELECTRODE HOUSING FLOW MODULE	Sample Water Flow Control Module With Signal Output, Valve. (Clamp Connected)	✗	
 600112572000000 ELECTRODE HOUSING CLIP SET	4 Clips And 1 Each Of Open And Close Couplings To Join The Housing.	✗	









SYSTEM OMNICON PH FCL

pH & Amperometric Free Chlorine Measurement and Control System

- All connection components mounted on 60x90 panel
- OmniCon pH FCL
- Dirt trap pre-filter
- Inlet-outlet records (6x8 mm) and sampling valve
- Calibration liquids and calibration stand
- pH electrode and Amperometric free chlorine cell (0-10 ppm)

Stock Code	Model	Description	Package Sizes/cm W-L-H	Packed Weight/Kg
101210010240000	SYSTEM OMNICON PH FCL	Ph & Amperometric Free Chlorine Measurement And Controlling System	96 x 66 x 16	8,25

Spare Parts - Options

Stock Code	Stock Name	Description	Included in Package
 201010010000000	OMNICON PH FCL	Ph & Amperometric Free Chlorine Measurement And Controller Device	✓
 421000010150010	ELECTRODE PH 1M SENSOR X5	Combined Ph Electrode With 1 Meter Cable And Bnc Connector	✓
 600510010111000	AMPEROMETRIC FREE CHLORINE CELL	Amperometric Free Chlorine Electrode 0 10 Ppm (Cu-Pt) . With 1 Meter Cable, Bnc Connector.	✓
 600112410010000	ELECTRODE HOUSING SET FCL	Electrode Housing For 12mm Sensors. With Double input, Dirt Trap Pre Filter-Ed And Amperometric Free Chlorine Electrode.	✓
 600110400100010	MOUNTING SET FOR SYSTEM 2	Connection Sets for Electrode Housings	✓
 600112551000000	ELECTRODE HOUSING FLOW MODULE	Sample Water Flow Control Module With Signal Output, Valve. (Clamp Connected)	✗
 600112572000000	ELECTRODE HOUSING CLIP SET	4 Clips And 1 Each Of Open And Close Couplings To Join The Housing.	✗

SYSTEM OMNICON PH ORP FCL SELECTIVE









pH & ORP & Free Chlorine Measurement and Control System



- All connection components mounted on 60x120 panel
- Omnicon pH ORP FCL Selective
- Dirt trap pre-filter
- Electrode flow cell
- Inlet-outlet records (6x8 mm) and sampling valve
- Calibration liquids and calibration stand
- pH and ORP electrode
- 0-5 ppm ion selective free chlorine electrode

Stock Code	Model	Description	Package Sizes/cm W-L-H	Packed Weight/Kg
101311010320000	SYSTEM OMNICON PH ORP FCL SELECTIVE	Ph & Orp & Free Chlorine Measurement And Controlling System	126 x 66 x 16	9,30

Spare Parts - Options

Stock Code	Stock Name	Description	Included in Package
 201011010000010	OMNICON PH ORP FCL SELECTIVE	Ph & Orp & Free Chlorine Measurement And Controller Device	✓
 421000010150010	ELECTRODE PH 1M SENSOR X5	Combined Ph Electrode With 1 Meter Cable And Bnc Connector	✓
 421000110100030	ELECTRODE ORP 1M SENSOR X5	Combined Orp Electrode With 1 Meter Cable And Bnc Connector	✓
 421000320101020	ELECTRODE FCL/0 5 PPM SELECTIVE	Free Chlorine ion Selective Electrode 0 5 Ppm With 1 Meter Cable, Mic Connector.	✓
 600112520030000	ELECTRODE HOUSING SET 2-1SL	Electrode Housing Dirt Trap Pre Filter-Eded With Dual input For 12 mm Sensors And Single input For ion Selective Sensors	✓
 600110400100010	MOUNTING SET FOR SYSTEM 2	Connection Sets for Electrode Housings	✓
 600112551000000	ELECTRODE HOUSING FLOW MODULE	Sample Water Flow Control Module With Signal Output, Valve. (Clamp Connected)	✗
 600112572000000	ELECTRODE HOUSING CLIP SET	4 Clips And 1 Each Of Open And Close Couplings To Join The Housing.	✗











SYSTEM OMNICON PH ORP FCL

pH & ORP & Amperometric Free Chlorine Measurement and Control System

- All connection components mounted on 60x90 panel
- OmniCon pH ORP FCL
- Dirt trap pre-filter
- Inlet-outlet records (6x8 mm) and sampling valve
- Calibration liquids and calibration stand
- pH and ORP electrode
- Amperometric free chlorine cell (0-10 ppm)

Stock Code	Model	Description	Package Sizes/cm W-L-H	Packed Weight/Kg
101211010240000	SYSTEM OMNICON PH ORP FCL	Ph & Orp & Free Chlorine Measurement And Controlling System	96 x 66 x 16	8,45

Spare Parts - Options

	Stock Code	Stock Name	Description	Included in Package
	201011010000000	OMNICON PH ORP FCL	Ph & Orp & Free Chlorine Measurement And Controller Device	✓
	421000010150010	ELECTRODE PH 1M SENSOR XS	Combined Ph Electrode With 1 Meter Cable And Bnc Connector	✓
	421000110100030	ELECTRODE ORP 1M SENSOR XS	Combined Orp Electrode With 1 Meter Cable And Bnc Connector	✓
	600510010111000	AMPEROMETRIC FREE CHLORINE CELL	Amperometric Free Chlorine Electrode 0 10 Ppm (Cu-Pt) , With 1 Meter Cable, Bnc Connector.	✓
	600112410010000	ELECTRODE HOUSING SET FCL	Electrode Housing Dirt Trap Pre Filter-Eded With Dual input For 12 mm Sensors And Single input For Ion Selective Sensors	✓
	600110400100010	MOUNTING SET FOR SYSTEM 2	Connection Sets for Electrode Housings	✓
	600112551000000	ELECTRODE HOUSING FLOW MODULE	Sample Water Flow Control Module With Signal Output, Valve. (Clamp Connected)	✗
	600112572000000	ELECTRODE HOUSING CLIP SET	4 Clips And 1 Each Of Open And Close Couplings To Join The Housing.	✗









SYSTEM OMNICON PH H₂O₂ SELECTIVE pH & Hydrogen Peroxide Measurement and Control System

- All connection components mounted on 60x90 panel
- OmniCon pH hydrogen Selective
- Dirt trap pre-filter
- Electrode flow cell
- Inlet-outlet records (6x8 mm) and sampling valve
- Calibration liquids and calibration stand
- pH electrode and 0-200 ppm ion selective hydrogen peroxide electrode
- Optional 0-500 ppm ion selective hydrogen peroxide electrode

Stock Code	Model	Description	Package Sizes/cm W-L-H	Packed Weight/Kg
101210060220000	SYSTEM OMNICON PH HYDROGEN PEROXIDE	Ph & Hydrogen Peroxide Measurement And Controlling System	96 x 66 x 16	7,55

Spare Parts - Options

Stock Code	Stock Name	Description	Included in Package
 201010070000000 OMNICON PH H2O2	Ph & Hydrogen Peroxide Measurement And Controller Device	✓	
 421000010150010 ELECTRODE PH 1M SENSOR XS	Combined Ph Electrode With 1 Meter Cable And Bnc Connector	✓	
 421000720101010 ELECTRODE H2O2/O 500 PPM SELECTIVE	Hydrogen Peroxide Selective Electrode 0 500 Ppm With 1 Meter Cable And Mic Connector	✓	
 600112510050000 ELECTRODE HOUSING SET 1-1SL	Electrode Housing Dual input With Dirt Trap Pre Filter-Eded. For 12 mm Sensors And ion Selective Sensors	✓	
 600110400100010 MOUNTING SET FOR SYSTEM 2	Connection Sets for Electrode Housings	✓	
 600112551000000 ELECTRODE HOUSING FLOW MODULE	Sample Water Flow Control Module With Signal Output, Valve. (Clamp Connected)	✗	
 600112572000000 ELECTRODE HOUSING CLIP SET	4 Clips And 1 Each Of Open And Close Couplings To Join The Housing.	✗	



SYSTEM OMNICON FCL SELECTIVE

Free Chlorine Measurement and Control System

- All connection components mounted on 50x75 panel
- OmniCon FCL Selective
- Dirt trap pre-filter
- Electrode flow cell
- Inlet-outlet records (6x8 mm) and sampling valve
- Calibration rack
- 0-2 ppm ion selective free chlorine electrode
- With optional 0-5 ppm or 0-200 ppm ion selective free chlorine electrode preferences

Stock Code	Model	Description	Package Sizes/cm W-L-H	Packed Weight/Kg
101100010120000	SYSTEM OMNICON FCL SELECTIVE	Free Chlorine Selective Measurement And Controlling System	78 x 54 x 19	5.55

Spare Parts - Options

	Stock Code	Stock Name	Description	Included in Package
	201000080000000	OMNICON FCL SELECTIVE	Free Chlorine Selective Measurement And Controller Device	✓
	421000320101010	ELECTRODE FCL/0 2 PPM SELECTIVE	Free Chlorine ion Selective Electrode 0 2 Ppm With 1 Meter Cable And Mic Connector	✓
	600112510030000	ELECTRODE HOUSING SET 15L	Electrode Housing For ion Slective Sensor With Dirt Trap Pre Filter-Ed .	✓
	600110400100010	MOUNTING SET FOR SYSTEM 2	Connection Sets for Electrode Housings	✓
	600112551000000	ELECTRODE HOUSING FLOW MODULE	Sample Water Flow Control Module With Signal Output, Valve. (Clamp Connected)	✗
	600112572000000	ELECTRODE HOUSING CLIP SET	4 Clips And 1 Each Of Open And Close Couplings To Join The Housing.	✗

05 Systems

Omnicon Single Parameter Measurement and Control Systems







SYSTEM OMNICON FCL Free Chlorine Measurement and Control System

- All connection components mounted on 60x90 panel
- OmniCon FCL WTAC
- Dirt trap pre-filter
- Electrode flow cell
- Inlet-outlet records (6x8 mm) and sampling valve
- Calibration rack
- Amperometric free chlorine cell (0-10 ppm)

Stock Code	Model	Description	Package Sizes/cm W-L-H	Packed Weight/Kg
101100010240000	SYSTEM OMNICON FCL	Amperometric Free Chlorine Measurement And Controlling System	96 x 66 x 16	7,95

Spare Parts - Options

Stock Code	Stock Name	Description	Included in Package
 201000010000000 OMNICON FCL	Free Chlorine Measurement And Controller Device Wtac	✓	
 600510010111000 AMPEROMETRIC FREE CHLORINE CELL	Amperometric Free Chlorine Electrode 0 10 Ppm (Cu-Pt) , With 1 Meter Cable, Bnc Connector.	✓	
 600112410010000 ELECTRODE HOUSING SET FCL	Electrode Housing For 12mm Sensors. With Double input, Dirt Trap Pre Filter-Ed And Amperometric Free Chlorine Electrode.	✓	
 600110400100010 MOUNTING SET FOR SYSTEM 2	Connection Sets for Electrode Housings	✓	







SYSTEM OMNICON OZONE

Ozone Measurement and Control System

- All connection components mounted on 50x75 panel
- OmniCon Ozone
- Dirt trap pre-filter
- Electrode flow cell
- Inlet-outlet records (6x8 mm) and sampling valve
- Calibration rack
- 0-2 ppm ion selective ozone electrode
- With optional 0-5 ppm or 0-20 ppm ion selective ozone electrode preferences

Stock Code	Model	Description	Package Sizes/cm W-L-H	Packed Weight/Kg
101100050120000	SYSTEM OMNICON OZONE	Ozone Measurement And Controlling System	78 x 54 x 19	5,55

Spare Parts - Options

Stock Code	Stock Name	Description	Included in Package
 201000050000000	OMNICON O3	Ozone Measurement And Controlling Device O3	✓
 421000620101010	ELECTRODE OZONE /O 2 PPM SELECTIVE	ion Selective Ozone Electrode 0 2 Ppm With 1 Meter Cable, Mic Connector.	✓
 600112510030000	ELECTRODE HOUSING SET 1SL	Electrode Housing For ion Slective Sensor With Dirt Trap Pre Filter-Ed .	✓
 600110400100010	MOUNTING SET FOR SYSTEM 2	Connection Sets for Electrode Housings	✓
 600112551000000	ELECTRODE HOUSING FLOW MODULE	Sample Water Flow Control Module With Signal Output, Valve. (Clamp Connected)	✗
 600112572000000	ELECTRODE HOUSING CLIP SET	4 Clips And 1 Each Of Open And Close Couplings To Join The Housing.	✗









SYSTEM OMNICON PH CLO₂p TEMP

pH & Potentiostatic Chlorine Dioxide & Temperature Measurement and Control System

- All connection components mounted on 60x90 panel
- OmniCon pH CLO₂p Temp
- Dirt trap pre-filter
- Electrode flow cell
- Inlet-outlet records (6x8 mm) and sampling valve
- Calibration liquids and calibration stand
- pH electrode and 0-10 ppm potentiostatic chlorine dioxide electrode
- Temperature sensor

Stock Code	Model	Description	Package Sizes/cm W-L-H	Packed Weight/Kg
101102070120000	SYSTEM OMNICON 1010 PH CLO ₂ p TEMP	Ph & Chlorine Dioxide - Potansiostatic & Temperature Measurement And Controlling System	96 x 66 x 16	8,35

Spare Parts - Options

Stock Code	Stock Name	Description	Included in Package
 201015000000000 OMNICON 1010 PH CLO ₂ p TEMP	Ph & Chlorine Dioxide - Potansiostatic & Temperature Measurement And Controlling Device	✓	
 421000010150010 ELECTRODE PH 1M SENSOR XS	Combined Ph Electrode With 1 Meter Cable And Bnc Connector	✓	
 421002320003010 ELECTRODE POTANSIOSTATIC S8	Potentiostatic Chlorine Dioxide Electrode. With S8 Connector, 0 10 Ppm	✓	
 760204060000007 CABLE SET E COAXIAL SENSOR S8-BNC 1.5 MT	1.5 Meter Cable For Glass Ph Electrode With S8 Connector.	✓	
 600112560000000 ELECTRODE HOUSING SET POTENSIOSTATIC	Electrode Flow Housing Set.	✓	
 410270010000000 FLOWREG	Flow Compensator Measurement And Control Kit	✓	
 600110400100010 MOUNTING SET FOR SYSTEM 2	Connection Sets for Electrode Housings	✓	



SYSTEM OMNICON CLO₂

Chlorine Dioxide Measurement and Control System

- All connection components mounted on 50x75 panel
- OmniCon chlorine Dioxide
- Dirt trap pre-filter
- Electrode flow cell
- Inlet-outlet records (6x8 mm) and sampling valve
- Calibration rack
- 0-2 ppm ion selective chlorine dioxide electrode
- Optional 0-10 ppm ion selective chlorine dioxide electrode

Stock Code	Model	Description	Package Sizes/cm W-L-H	Packed Weight/Kg
101100070120000	SYSTEM OMNICON CHLORINE DIOXIDE	Chlorine Dioxide Measurement And Controlling System	78 x 54 x 19	5,55

Spare Parts - Options

	Stock Code	Stock Name	Description	Included in Package
	201011070000000	OMNICON CLO ₂	Chlorine Dioxide Measurement And Controlling Device	✓
	421000520101020	ELECTRODE CLO ₂ /O ₂ 2 PPM SELECTIVE	Ion Selective Chlorine Dioxide Electrode 0-2 Ppm . With 1 Meter Cable, Mic Connector	✓
	600112510030000	ELECTRODE HOUSING SET 15L	Electrode Housing For Ion Slective Sensor With Dirt Trap Pre Filter-Ed .	✓
	600110400100010	MOUNTING SET FOR SYSTEM 2	Connection Sets for Electrode Housings	✓
	600112551000000	ELECTRODE HOUSING FLOW MODULE	Sample Water Flow Control Module With Signal Output, Valve. (Clamp Connected)	✗
	600112572000000	ELECTRODE HOUSING CLIP SET	4 Clips And 1 Each Of Open And Close Couplings To Join The Housing.	✗









SYSTEM OMNICON H₂O₂ Hydrogen Peroxide Measurement and Control System

- All connection components mounted on 50x75 panel
- OmniCon Hydrogen Peroxide
- Dirt trap pre-filter
- Electrode flow cell
- Inlet-outlet records (6x8 mm) and sampling valve
- Calibration rack
- 0-200 ppm ion selective hydrogen peroxide electrode
- Optional 0-500 ppm ion selective hydrogen peroxide electrode

Stock Code	Model	Description	Package Sizes/cm W-L-H	Packed Weight/Kg
101100060120000	SYSTEM OMNICON HYDROGEN PEROXIDE	Hydrogen Peroxide Measurement And Controlling System	78 x 54 x 19	5,55

Spare Parts - Options

Stock Code	Stock Name	Description	Included in Package
 201011060000000 OMNICON H2O2	Hydrogen Peroxide Measurement And Controlling Device	✓	
 421000720101010 ELECTRODE H2O2/0 500 PPM SELECTIVE	Ion Selective Hydrogen Peroxide Electrode With 1 Meter Cable, Mic Connector, 0 500 Ppm	✓	
 600112510030000 ELECTRODE HOUSING SET 1SL	Electrode Housing For Ion Selective Sensor With Dirt Trap Pre Filter-Ed .	✓	
 600110400100010 MOUNTING SET FOR SYSTEM 2	Connection Sets for Electrode Housings	✓	
 600112551000000 ELECTRODE HOUSING FLOW MODULE	Sample Water Flow Control Module With Signal Output, Valve. (Clamp Connected)	✗	
 600112572000000 ELECTRODE HOUSING CLIP SET	4 Clips And 1 Each Of Open And Close Couplings To Join The Housing.	✗	









SYSTEM OMNICON PH

pH Measurement and Control System

- All connection components mounted on 50x75 panel
- OmniCon pH
- Dirt trap pre-filter
- Electrode flow cell
- Inlet-outlet records (6x8 mm) and sampling valve
- Calibration liquids and calibration stand
- pH electrode

Stock Code	Model	Description	Package Sizes/cm W-L-H	Packed Weight/Kg
101110000140000	SYSTEM OMNICON PH	Ph Measurement And Controlling System	78 x 54 x 19	4,70

Spare Parts - Options

	Stock Code	Stock Name	Description	Included in Package
	201010000000000	OMNICON PH	Ph Measurement And Controlling Device	✓
	421000010150010	ELECTRODE PH 1M SENSOR XS	Combined Ph Electrode With 1 Meter Cable And Bnc Connector	✓
	600112510010000	ELECTRODE HOUSING SET 1	Electrode Housing With A Dirt Trap Pre Filter-Ed For 12 mm Sensor.	✓
	600110400100010	MOUNTING SET FOR SYSTEM 2	Connection Sets for Electrode Housings	✓
	600112551000000	ELECTRODE HOUSING FLOW MODULE	Sample Water Flow Control Module With Signal Output, Valve. (Clamp Connected)	✗
	600112572000000	ELECTRODE HOUSING CLIP SET	4 Clips And 1 Each Of Open And Close Couplings To Join The Housing.	✗

05 Systems

Omnicon Single Parameter Measurement and Control Systems









SYSTEM OMNICON ORP

ORP Measurement and Control System

- All connection components mounted on 50x75 panel
- OmniCon ORP
- Dirt trap pre-filter
- Electrode flow cell
- Inlet-outlet records (6x8 mm) and sampling valve
- Calibration liquids and calibration stand
- ORP electrode

Stock Code	Model	Description	Package Sizes/cm W-L-H	Packed Weight/Kg
101101000140000	SYSTEM OMNICON ORP	Orp Measurement And Controlling System	78 x 54 x 19	4,70

Spare Parts - Options

	Stock Code	Stock Name	Description	Included in Package
	201001000000000	OMNICON ORP	Orp Measurement And Controlling Device	✓
	421000110100030	ELECTRODE ORP 1M SENSOR X5	Combined Orp Electrode With 1 Meter Cable And Bnc Connector	✓
	600112510010000	ELECTRODE HOUSING SET 1	Electrode Housing With A Dirt Trap Pre Filter-Ed For 12 mm Sensor.	✓
	600110400100010	MOUNTING SET FOR SYSTEM 2	Connection Sets for Electrode Housings	✓
	600112551000000	ELECTRODE HOUSING FLOW MODULE	Sample Water Flow Control Module With Signal Output, Valve. (Clamp Connected)	✗
	600112572000000	ELECTRODE HOUSING CLIP SET	4 Clips And 1 Each Of Open And Close Couplings To Join The Housing.	✗









SYSTEM OMNICON CONDUCTIVITY

Conductivity & Temperature Measurement and Control System

- All connection components mounted on 50x75 panel
- OmniCon CON
- Dirt trap pre-filter
- Electrode flow cell
- Inlet-outlet records (6x8) and sampling valve
- Calibration liquids and calibration stand
- Conductivity electrode

Stock Code	Model	Description	Package Sizes/cm W-L-H	Packed Weight/Kg
101100100140000	SYSTEM OMNICON CON	Conductivity Measurement And Controlling System	78 x 54 x 19	4,70

Spare Parts - Options

	Stock Code	Stock Name	Description	Included in Package
	201000100000000	OMNICON CON	Conductivity Measurement And Controlling Device	✓
	421000290102060	ELECTRODE CONDUCTIVITY GRAPHITE 2CELL CT25 EN06 MIC NTC10K K1 A51	2-Cell Graphite Conductivity Electrode With1 Meter Cable, Mic Connector	✓
	600112510010000	ELECTRODE HOUSING SET 1	Electrode Housing With A Dirt Trap Pre Filter-Ed For 12 mm Sensor.	✓
	600110400100010	MOUNTING SET FOR SYSTEM 2	Connection Sets for Electrode Housings	✓
	600112551000000	ELECTRODE HOUSING FLOW MODULE	Sample Water Flow Control Module With Signal Output, Valve. (Clamp Connected)	✗
	600112572000000	ELECTRODE HOUSING CLIP SET	4 Clips And 1 Each Of Open And Close Couplings To Join The Housing.	✗









SYSTEM AQUAMETER PH

pH Measurement and Control System

- All connection components mounted on 60x45 panel
- Aquameter pH
- Dirt trap pre-filter
- Electrode flow cell
- Inlet-outlet records (6x8 mm) and sampling valve
- Calibration liquids and calibration stand
- pH electrode (model E)

Stock Code	Model	Description	Package Sizes/cm W-L-H	Packed Weight/Kg
104110000000140	SYSTEM AQUAMETER PH	pH Measurement And Controlling System	65 x 51 x 16	4,20

Spare Parts - Options

	Stock Code	Stock Name	Description	Included in Package
	201200000000000	AQUAMETER PH	Ph Measurement And Controlling Device	✓
	421000000100010	ELECTRODE PH 1MT E	Combined Ph Electrode With 1 Meter Cable And Bnc Connector	✓
	600112510010000	ELECTRODE HOUSING SET 1	Electrode Housing With A Dirt Trap Pre Filter-Ed For 12 mm Sensor.	✓
	600110400100010	MOUNTING SET FOR SYSTEM 2	Connection Sets for Electrode Housings	✓
	600112510000000	ELECTRODE HOUSING FLOW MODULE	Sample Water Flow Control Module With Signal Output, Valve. (Clamp Connected)	✗
	600112572000000	ELECTRODE HOUSING CLIP SET	4 Clips And 1 Each Of Open And Close Couplings To Join The Housing.	✗

SYSTEM AQUAMETER ORP







ORP Measurement and Control System



- All connection components mounted on 60x45 panel
- Aquameter ORP
- Dirt trap pre-filter
- Electrode flow cell
- Inlet-outlet records (6x8 mm) and sampling valve
- Calibration liquids and calibration stand
- ORP electrode (model E)

Stock Code	Model	Description	Package Sizes/cm W-L-H	Packed Weight/Kg
104111000000140	SYSTEM AQUAMETER ORP	Orp Measurement And Controlling System	65 x 51 x 16	4,20

Spare Parts - Options

	Stock Code	Stock Name	Description	Included in Package
	201210000000000	AQUAMETER ORP	Orp Measurement And Controlling Device	✓
	421000100100010	ELECTRODE ORP 1M E	Combined Orp Electrode With 1 Meter Cable And Bnc Connector	✓
	600112510010000	ELECTRODE HOUSING SET 1	Electrode Housing With A Dirt Trap Pre Filter-Ed For 12 mm Sensor.	✓
	600110400100010	MOUNTING SET FOR SYSTEM 2	Connection Sets for Electrode Housings	✓
	600112551000000	ELECTRODE HOUSING FLOW MODULE	Sample Water Flow Control Module With Signal Output, Valve. (Clamp Connected)	✗
	600112572000000	ELECTRODE HOUSING CLIP SET	4 Clips And 1 Each Of Open And Close Couplings To Join The Housing.	✗









SYSTEM AQUAMETER CON

Conductivity & Temperature Measurement and Control System

- All connection components mounted on 60x45 panel
- Aquameter CON
- Dirt trap pre-filter
- Electrode flow cell
- Inlet-outlet records (6x8 mm) and sampling valve
- Calibration liquids and calibration stand
- Conductivity electrode

Stock Code	Model	Description	Package Sizes/cm W-L-H	Packed Weight/Kg
104112000000140	SYSTEM AQUAMETER CON	Conductivity Measurement And Controlling System	65 x 51 x 16	4,20

Spare Parts - Options

	Stock Code	Stock Name	Description	Included in Package
	201220000000000	AQUAMETER CON	Conductivity Measurement And Controlling Device	✓
	421000290102060	ELECTRODE CONDUCTIVITY GRAPHITE 2CELL CT25 EN06 MIC NTC10K K1 AS1	2-Cell Graphite Conductivity Electrode With 1 Meter Cable, Mic Connector	✓
	600112510010000	ELECTRODE HOUSING SET 1	Electrode Housing With A Dirt Trap Pre Filter-Ed For 12 mm Sensor.	✓
	600110400100010	MOUNTING SET FOR SYSTEM 2	Connection Sets for Electrode Housings	✓
	600112551000000	ELECTRODE HOUSING FLOW MODULE	Sample Water Flow Control Module With Signal Output, Valve. (Clamp Connected)	✗
	600112572000000	ELECTRODE HOUSING CLIP SET	4 Clips And 1 Each Of Open And Close Couplings To Join The Housing.	✗

SYSTEM AQUAMETER TOWER 01







pH & Conductivity & Temperature Measurement and Control System



- All connection components mounted on 60x45 panel
- Aquameter pH and Aquameter CON
- Dirt trap pre-filter
- Electrode flow cell
- Inlet-outlet records (6x8) and sampling valve
- Calibration liquids and calibration stand
- pH electrode (model E) and conductivity electrode

Stock Code	Model	Description	Package Sizes/cm W-L-H	Packed Weight/Kg
104124000000200	SYSTEM AQUAMETER TOWER 01	Ph & Conductivity Tower Blow Down System	65 x 51 x 16	5,95

Spare Parts - Options

Stock Code	Stock Name	Description	Included in Package
 201200000000000	AQUAMETER PH	Ph Measurement And Controlling Device	✓
 201220000000000	AQUAMETER CON	Conductivity Measurement And Controlling Device	✓
 421000000100010	ELECTRODE PH 1MT E	Combined Ph Electrode With 1 Meter Cable And Bnc Connector	✓
 421000290102060	ELECTRODE CONDUCTIVITY GRAPHITE 2CELL CT25 EN06 MIC NTC10K K1 AS1	2-Cell Graphite Conductivity Electrode With 1 Meter Cable, Mic Connector	✓
 600112520010000	ELECTRODE HOUSING SET 2	Electrode Housing With A Dirt Trap Pre Filter-Ed For 12 mm Sensor.	✓
 600110400100010	MOUNTING SET FOR SYSTEM 2	Connection Sets for Electrode Housings	✓
 600112551000000	ELECTRODE HOUSING FLOW MODULE	Sample Water Flow Control Module With Signal Output, Valve. (Clamp Connected)	✗
 600112572000000	ELECTRODE HOUSING CLIP SET	4 Clips And 1 Each Of Open And Close Couplings To Join The Housing.	✗









SYSTEM OMNICON TOWER

pH & Conductivity & Temperature Measurement and Control System

- All connection components mounted on 60x90 panel
- OmniCon pH CON
- Dirt trap pre-filter
- Electrode flow cell
- Inlet-outlet records (6x8 mm) and sampling valve
- Calibration liquids and calibration stand
- Ultem body pH electrode and conductivity electrode

Stock Code	Model	Description	Package Sizes/cm W-L-H	Packed Weight/Kg
101210100200000	SYSTEM OMNICON TOWER	Ph & Conductivity Tower Blow Down System	96 x 66 x 16	7,05

Spare Parts - Options

Stock Code	Stock Name	Description	Included in Package
 201010100000000	OMNICON PH CON	Ph & Conductivity Measurement And Controlling Device	✓
 421000010150010	ELECTRODE PH 1M SENSOR XS	Combined Ph Electrode With 1 Meter Cable And Bnc Connector	✓
 421000290102060	ELECTRODE CONDUCTIVITY GRAPHITE 2CELL CT25 EN06 MIC NTC10K K1 AS1	2-Cell Graphite Conductivity Electrode With 1 Meter Cable, Mic Connector	✓
 600112520010000	ELECTRODE HOUSING SET 2	Electrode Housing With Dual input Dirt Trap Pre Filter-Ed For 12 mm Sensors. For All Models,	✓
 600110400100010	MOUNTING SET FOR SYSTEM 2	Connection Sets for Electrode Housings	✓
 600112510000000	ELECTRODE HOUSING FLOW MODULE	Sample Water Flow Control Module With Signal Output, Valve. (Clamp Connected)	✗
 600112572000000	ELECTRODE HOUSING CLIP SET	4 Clips And 1 Each Of Open And Close Couplings To Join The Housing.	✗

SYSTEM OMNICON TOWER AS







pH & Conductivity & Temperature Measurement and Control System



- All connection components mounted on 60x90 panel
- OmniCon pH CON
- Dirt trap pre-filter
- Electrode flow cell
- Inlet-outlet records (6x8 mm) and sampling valve
- Calibration liquids and calibration stand
- Glass pH electrode and conductivity electrode

Stock Code	Model	Description	Package Sizes/cm W-L-H	Packed Weight/Kg
101210100200005	SYSTEM OMNICON TOWER AS	pH & Conductivity & Temperature Tower Blow Down System	96 x 66 x 16	7,05

Spare Parts - Options

	Stock Code	Stock Name	Description	Included in Package
	201010100000000	OMNICON PH CON	Ph & Conductivity Measurement And Controlling Device	✓
	421000050002020	PH A-58 GLASS SENSOR	Glass Ph Electrode With 58 Connector	✓
	610204060000007	CABLE SET E COAXIAL SENSOR 58-BNC 1.5 MT	1.5 Meter Cable For Glass Ph Electrode With 58 Connector.	✓
	421000290102060	ELECTRODE CONDUCTIVITY GRAPHITE 4CELL PT100K0,45 A51	2-Cell Graphite Conductivity Electrode With1 Meter Cable, Mic Connector	✓
	600112520050000	ELECTRODE HOUSING SET 2PG13,5-WITH FLOW SENSOR	Electrode Housing With Double input Dirt Trap Pre Filtered For Pg13.5-Link Sensors With Flow Sensor.	✓
	600110400100010	MOUNTING SET FOR SYSTEM 2	Connection Sets for Electrode Housings	✓

SYSTEM OMNICON TOWER S272G





pH & Conductivity & Temperature Measurement and Control System



- All connection components mounted on 60x90 panel
- OmniCon pH CON
- Dirt trap pre-filter
- Electrode flow cell
- Inlet-outlet records (6x8 mm) and sampling valve
- Calibration liquids and calibration stand
- S272 pH electrode and conductivity electrode

Stock Code	Model	Description	Package Sizes/cm W-L-H	Packed Weight/Kg
101210100200001	SYSTEM OMNICON TOWER S272G	Ph & Conductivity & Temperature Tower Blow Down System	96 x 66 x 16	7,25

Spare Parts - Options

Stock Code	Stock Name	Description	Included in Package
 201010100000000	OMNICON PH CON	Ph & Conductivity Measurement And Controlling Device	✓
 421000010600090	ELECTRODE PH S272CD 2D BNC 6M SENSOR X5	Ph Electrode Double Referenced With 6 Meter Cable, Bnc Connector.	✓
 421000290102060	ELECTRODE CONDUCTIVITY GRAPHITE 2CELL CT25 EN06 MIC NTC10K K1 AS1	Conductivity Electrode With1 Meter Cable, Mic Connector	✓
 600112510070000	ELECTRODE HOUSING SET 1PG13,5-S272-WITH FLOW SENSOR	Electrode Housing With Flow Sensor With 1X Pg13,5 And 1X S272 Sensor input And With Dirt Trap Pre Filter-Ed.	✓
 600110400100010	MOUNTING SET FOR SYSTEM 2	Connection Sets for Electrode Housings	✓

SYSTEM OMNICON PH ORP CON FP







pH & ORP & Conductivity & Temperature & Trace Element Measurement and Control System



- Fittings are mounted inside the panel with the cover
- OmniCon pH ORP CON FP
- Dirt trap pre-filter
- Electrode flow cell
- Inlet-outlet records (6x8 mm) and sampling valve
- Calibration liquids and calibration stand
- Glass pH, glass ORP electrode and conductivity electrode
- Trace element sensor (0-300 ppb PTSA)

Stock Code	Model	Description	Package Sizes/cm W-L-H	Packed Weight/Kg
431001010302000	SYSTEM OMNICON PH ORP CON FP	Ph & Orp & Conductivity & Temperature & Trace Element Measurement And Controlling System	86 x 66 x 32	19,05

Spare Parts - Options

Stock Code	Stock Name	Description	Included in Package
 432012000000300	OMNICON PH ORP CON FP	Ph & Orp & Conductivity & Temperature & Trace Element Measuring And Controlling Device	✓
 704421000000053	ELECTRODE INLINE FLUOROMETER PTSA	inline Optical Trace Element Sensor	✓
 42100050002020	PH A-S8 GLASS SENSOR	Glass Ph Electrode With S8 Connector	✓
 421000150002010	ORP A-S8 GLASS SENSOR	Glass Orp Electrode With S8 Connector	✓
 610204060000007	CABLE SET E COAXIAL SENSOR S8-BNC 1.5 MT	1.5 Meter Cable For Glass Ph Electrode With S8 Connector.	✓
 421000250101040	ELECTRODE CONDUCTIVITY GRAPHITE 4CELL PT100KD,45 A51	4-Cell Graphite Conductivity Electrode With 1 Meter Cable, Mic Connector	✓









SYSTEM OMNICON PH ORP CON

pH & ORP & Conductivity & Temperature Measurement and Control System

- All connection components mounted on 60x90 panel
- OmniCon pH ORP CON
- Dirt trap pre-filter
- Electrode flow cell
- Inlet-outlet records (6x8 mm) and sampling valve
- Calibration liquids and calibration stand
- pH, ORP and conductivity electrode

Stock Code	Model	Description	Package Sizes/cm W-L-H	Packed Weight/Kg
101211100300000	SYSTEM OMNICON PH ORP CON	Ph & Orp & Conductivity Measurement And Controlling System	96 x 66 x 16	7,25

Spare Parts - Options

Stock Code	Stock Name	Description	Included in Package
 201011100000000	OMNICON PH ORP CON	Ph & Orp & Conductivity Measurement And Controlling Device	✓
 421000010150010	ELECTRODE PH 1M SENSOR XS	Combined Ph Electrode With 1 Meter Cable And Bnc Connector	✓
 421000110100030	ELECTRODE ORP 1M SENSOR XS	Combined Orp Electrode With 1 Meter Cable And Bnc Connector	✓
 421000290102060	ELECTRODE CONDUCTIVITY GRAPHITE 2CELL CT25 EN06 MIC NTC10K K1 AS1	2-Cell Graphite Conductivity Electrode With 1 Meter Cable, Mic Connector	✓
 600112530010000	ELECTRODE HOUSING SET 3	Electrode Housing With Triple input And Dirt Trap Pre Filter-Ed. For 12 mm Sensors.	✓
 600110400100010	MOUNTING SET FOR SYSTEM 2	Connection Sets for Electrode Housings	✓
 600112551000000	ELECTRODE HOUSING FLOW MODULE	Sample Water Flow Control Module With Signal Output, Valve. (Clamp Connected)	✗
 600112572000000	ELECTRODE HOUSING CLIP SET	4 Clips And 1 Each Of Open And Close Couplings To Join The Housing.	✗



06 Sensors

Sensors are the equipment that transmits signals from the process water, air or a liquid to the measuring device. They are manufactured from the materials suitable for the operating conditions of industrial processes such as Epoxy, Polycarbonate, Glass, SS316, Teflon, Ceramics, Polypropylene, PVC and PVDF.

The AnTech sensor family performs high-accuracy, wide-range measurements and instantly transmits measurements. It offers you a wide range of products for your choice of sensors for drinking water, wastewater, cooling towers, swimming pools, leather plants, textile plants, dye plants, milk plants, beverage plants, food plants and other industrial processes.

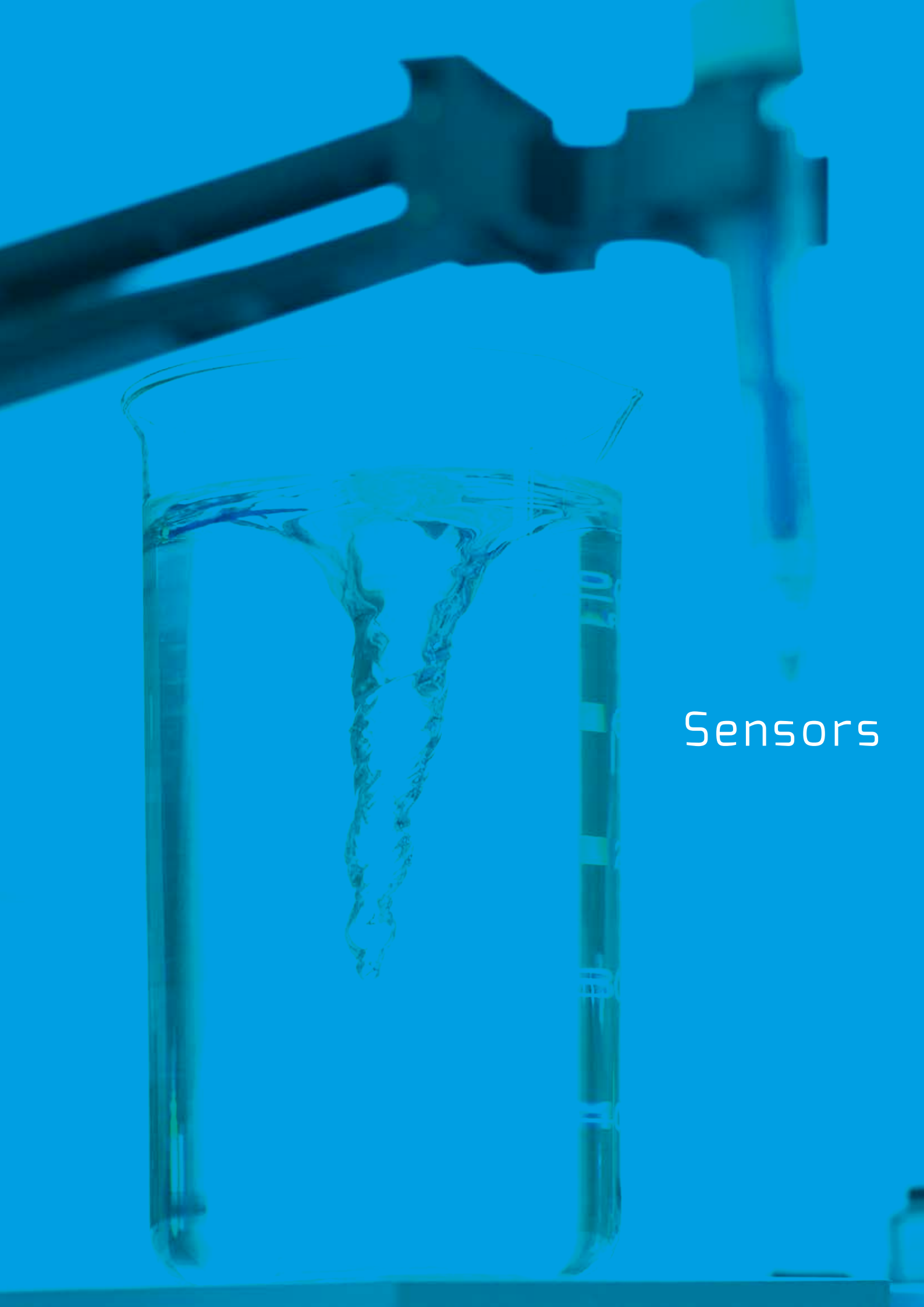

Sensors



ELECTRODE PH SENSOR XS

Ultem Body Single Reference pH Sensor

- Durable and low-maintenance Ultem® body structure
- High precision in full pH range (0-14)
- Instant ready-to-use construction and storage bottle for long shelf life
- Easy connection with direct BNC connector
- Non-refillable or maintenance-free structure thanks to its closed gel-filled design
- Accurate measurement in unknown and demanding samples thanks to sealed reference design
- 1 meter, 6 meters, 15 meters cable length option

Stock Code	Model	Package Sizes/cm W-L-H	Packed Weight/Kg
421000010150010	ELECTRODE PH 1M SENSOR XS	6 x 19,5 x 6	0,090
421000010600010	ELECTRODE PH 6M SENSOR XS	6 x 19,5 x 6	0,158
421000011500010	ELECTRODE PH 15M SENSOR XS	6 x 19,5 x 6	0,290

Technical Specifications

Measuring Range	0 - 14 pH (Na ⁺ error pH > 12.3)
Body Specifications	Ultem® / 12 mm / 120 mm
Max. Pressure	6 Bar
Temperature Range	0-80 °C
Min. Conductivity	100 uS
Junction No	Single
Junction Material	Pellon
Reference Gel	3.5 M KCl/AgCl/KNO ₃
Connector	BNC
Cable Length	1 meter / 6 meters / 15 meters



ELECTRODE PH E

Single Reference pH Sensor with Polycarbonate Body

- High strength with polycarbonate body structure
- High precision in full pH range (0-14)
- Instant ready-to-use construction and storage bottle for long shelf life
- Easy connection with direct BNC connector
- Non-refillable or maintenance-free structure thanks to its closed gel-filled design
- Accurate measurement in unknown and demanding samples thanks to sealed reference design
- 1 meter, 6 meters, 15 meters cable length option

Stock Code	Model	Package Sizes/cm W-L-H	Packed Weight/Kg
421000000100010	ELECTRODE PH 1MT E	7 x 23 x 5	0,128
421000000600010	ELECTRODE PH 6MT E	7 x 23 x 5	0,196
421000001500010	ELECTRODE PH 15MT E	7 x 23 x 5	0,290

Technical Specifications

Measuring Range	0 - 14 pH (Na ⁺ error pH > 12.3)
Body Specifications	PC / 12 mm / 120 mm
Max. Pressure	6 Bar
Temperature Range	0-60 °C
Min. Conductivity	100 uS
Junction No:	Single
Junction Material	1 Pellon
Reference Gel	3.5 M KCl/AgCl
Connector	BNC
Cable Length	1 meter / 6 meters / 15 meters

ELECTRODE PH S272CD SENSOR XS

PPS Body Double Reference Flat Surface pH Sensor

- Longer sensor life with anti-contamination design thanks to dual reference technology
- Precise and repeatable measurements in unknown and challenging samples thanks to its wide measurement surface and reference structure
- High fracture-resistant flat measuring surface
- High performance in dirty/wastewater structures thanks to its flat surface end structure
- Self-cleaning design with fluid flow thanks to its measurement surface structure
- Versatile design for immersion, electrode housing and in-line assemblies (3/4" NPT)
- Highly chemical resistant PPS body
- Static design with integrated cable assembly



Stock Code	Model	Package Sizes/cm W-L-H	Packed Weight/Kg
421000010600090	ELECTRODE PH S272CD 20 BNC 6M SENSOR XS	6 x 19,5 x 6	0,255
421000010600100	ELECTRODE PH S272CD HF 6M SENSOR XS	6 x 19,5 x 6	0,255

Technical Specifications

Measuring Range	0 - 14 pH (Na+ error pH > 12.3)
Body Specifications	Ryton® Polyphenylene Sulphide (PPS) / 3/4" NPT
Max. Pressure	7.5 Bar
Temperature Range	0-100 °C
Min. Conductivity	100 uS
Junction No:	Double
Junction Material	HDPE
Reference Gel	3.5 M KCl/AgCl
Connector	BNC
Cable Length	6 metre

ELECTRODE PH A-S8 GLASS SENSOR

Single Reference S8 pH Sensor with Glass Body



- High chemical strength and high performance in dirty/wastewater applications thanks to the glass body surface
- Precise and repeatable measurements thanks to a wide measuring surface
- Instant ready-to-use construction and storage bottle for long shelf life
- Non-refillable or maintenance-free structure thanks to its closed gel-filled design
- High accuracy in unknown and demanding samples thanks to its sealed special ceramic ring reference structure
- Wireless purchase option and easy cable change with connection connector (S8-BNC)
- Additional salt reserve for long service life

Stock Code	Model	Package Sizes/cm W-L-H	Packed Weight/Kg
421000050002020	PH A-S8 GLASS SENSOR ***	7 x 23 x 5	0,205
<i>There is no cable in the product. 1.5 mt and 6 mt cable options are available in the bottom line.</i>			
760204060000007	CABLE SET E COAXIAL SENSOR S8-BNC 1.5 MT	--	--
760204060000006	CABLE SET E COAXIAL SENSOR S8-BNC 6 MT	--	--

Technical Specifications

Measuring Range	0 - 14 pH (Na ⁺ error pH > 12.3)
Body Specifications	Glass / 12 mm / 120 mm / PG13.5
Max. Pressure	6 Bar
Temperature Range	0-80 °C
Min. Conductivity	100 uS
Junction No:	Single
Junction Material	Annular Ceramic
Reference Gel	Ag/AgCl
Connector	S8/BNC
Cable Length	1.5 meter / 6 meters

ELECTRODE PH A1M-BNC GLASS SENSOR

Single Reference pH Sensor with Glass Body



- High chemical strength and high performance in clean water applications thanks to the glass body surface
- Precise and repeatable measurements thanks to a wide measuring surface
- Instant ready-to-use construction and storage bottle for long shelf life
- Non-refillable or maintenance-free structure thanks to its closed gel-filled design
- Accurate measurement in unknown and demanding samples thanks to sealed reference design
- Easy to use thanks to a 1-meter cable and BNC connection
- Additional salt reserve for long service life

Stock Code	Model	Package Sizes/cm W-L-H	Packed Weight/Kg
421000050100010	PH A1M-BNC GLASS SENSOR	6 x 19,5 x 6	0,220

Technical Specifications

Measuring Range	0 - 14 pH (Na+ error pH > 12.3)
Body Specifications	Glass / 12 mm / 100 mm
Max, Pressure	6 Bar
Temperature Range	0-80 °C
Min. Conductivity	100 uS
Junction No:	Single
Junction Material	Ceramic Pin
Reference Gel	Ag/AgCl
Connector	BNC
Cable Length	1 meter

ELECTRODE PH LC SENSOR XS

Ultem Body Single Reference Low Conductivity pH Sensor



- Durable and low-maintenance Ultem® body structure
- High accuracy and long life for samples of low conductivity
- High precision in full pH range (0-14)
- Instant ready-to-use construction and storage bottle for long shelf life
- Easy connection with direct BNC connector
- Non-refillable or maintenance-free structure thanks to its closed gel-filled design
- Accurate measurement in unknown and demanding samples thanks to sealed reference design

Stock Code	Model	Package Sizes/cm W-L-H	Packed Weight/Kg
421000010600020	ELECTRODE PH 6M LC SENSOR XS	0,158	0,158

Technical Specifications

Measuring Range	0 - 14 pH (Na ⁺ error pH > 12.3)
Body Specifications	Ultem / 12mm / 120mm
Max. Pressure	6 Bar
Temperature Range	0-80 °C
Min. Conductivity	0.5 uS
Junction No	Double
Junction Material	1 Pellon
Reference Gel	3.5 M KCl/AgCl/KNO ₃
Connector	BNC
Cable Length	6 meter



ELECTRODE PH 2200 SPEAR TYPE SENSOR XS

Spear Type Ultem Body Single Reference pH Sensor

- Bio-friendly Ultem® body for safe measurements in food and soil
- Robust, spear-structured tip for measuring semi-solid specimens
- Long life thanks to built-in protection against protein contamination
- High precision in full pH range (0-14)
- Instant ready-to-use construction and storage bottle for long shelf life
- Easy connection with direct BNC connector
- Non-refillable or maintenance-free structure thanks to its closed gel-filled design
- Accurate measurement in unknown and demanding samples thanks to sealed reference design

Stock Code	Model	Package Sizes/cm W-L-H	Packed Weight/Kg
421000010100040	ELECTRODE PH 2200 SPEAR TIP 1M SENSOR XS	6 x 19,5 x 6	0,092

Technical Specifications

Measuring Range	0 - 14 pH (Na ⁺ error pH > 12.3)
Body Specifications	Ultem / 12mm / 120mm
Max. Pressure	6 Bar
Temperature Range	0-80 °C
Min. Conductivity	100 uS
Junction No:	Double
Junction Material	Kynar and Pellon
Reference Gel	3.5 M KCl/AgCl/KNO ₃
Connector	BNC
Cable Length	1 meter / 6 meters / 15 meters

ELECTRODE ORP SENSOR XS

Epoxy Body Single Reference ORP Sensor

- Durable and low-maintenance Epoxy body structure
- Reliable and accurate ORP/Redox measurement
- Instant ready-to-use construction and storage bottle for long shelf life
- Easy connection with direct BNC connector
- Non-refillable or maintenance-free structure thanks to its sealed gel-filled design
- Accurate measurement in unknown and demanding samples thanks to sealed reference design
- 1 meter, 6 meters, 15 meters cable length option



Stock Code	Model	Package Sizes/cm W-L-H	Packed Weight/Kg
421000110100030	ELECTRODE ORP 1M SENSOR XS	6 x 19,5 x 6	0,090
421000110600010	ELECTRODE ORP 6M SENSOR XS	6 x 19,5 x 6	0,158
421000111500010	ELECTRODE ORP 15M SENSOR XS	6 x 19,5 x 6	0,290

Technical Specifications

Measuring Range	-2000 mV / 2000 mV
Body Specifications	Epoxy / 12 mm / 120 mm
Max. Pressure	6 Bar
Temperature Range	0-80 °C
Min. Conductivity	100 uS
Junction No:	Single
Junction Material	Pellon
Reference Gel	3.5 M KCl/AgCl
Connector	BNC
Cable Length	1 meter / 6 meters / 15 meters



ELECTRODE ORP E

Single Reference ORP Sensor with Polycarbonate Body

- High strength with polycarbonate body structure
- Reliable and accurate ORP/Redox measurement
- Instant ready-to-use construction and storage bottle for long shelf life
- Easy connection with direct BNC connector
- Non-refillable or maintenance-free structure thanks to its sealed gel-filled design
- Accurate measurement in unknown and demanding samples thanks to sealed reference design
- 1 meter, 6 meters, 15 meters cable length option

Stock Code	Model	Package Sizes/cm W-L-H	Packed Weight/Kg
421000100100010	ELECTRODE ORP 1M E	7 x 23 x 5	0,128
421000100600010	ELECTRODE ORP 6M E	7 x 23 x 5	0,196
421000101500010	ELECTRODE ORP 15M E	7 x 23 x 5	0,290

Technical Specifications

Measuring Range	-2000 mV / 2000 mV
Body Specifications	PC / 12 mm / 120 mm
Max. Pressure	6 Bar
Temperature Range	0-60 °C
Min. Conductivity	100 uS
Junction No:	Single
Junction Material	Pellon
Reference Gel	3.5 M KCl/AgCl
Connector	BNC
Cable Length	1 meter / 6 meters / 15 meters

ELECTRODE ORP S272CD SENSOR XS

PPS Body Double Reference Flat-Surface ORP Sensor



- Longer with the design that prevents contamination thanks to double reference technology sensor life
- In unknown and challenging samples thanks to its wide measurement surface and reference structure precise and repeatable measurements
- High fracture-resistant flat measuring surface
- High performance in dirty/wastewater structures thanks to its flat surface end structure
- Self-cleaning design with fluid flow thanks to its measurement surface structure
- Versatile design for immersion, electrode housing and in-line assemblies (3/4" NPT)
- Highly chemical resistant PPS body
- Static design with integrated cable assembly

Stock Code	Model	Package Sizes/cm W-L-H	Packed Weight/Kg
421000110601020	ELECTRODE S272CD ORP 20 BNC 6M SENSOR XS	6 x 19,5 x 6	0,255

Technical Specifications

Measuring Range	-2000 mV / 2000 mV
Body Specifications	Ryton® Polyphenylene Sulphide (PPS) / 3/4" NPT
Max. Pressure	7.5 Bar
Temperature Range	0-80°C
Min. Conductivity	100 uS
Connector	BNC
Junction No:	Double
Junction Material	HDPE
Reference Gel	3.5 M KCl/AgCl
Cable Length	6 meters



ELECTRODE ORP S8 GLASS AS

Single Reference ORP Sensor with Glass Body

- High chemical strength and high performance in dirty/wastewater applications thanks to the glass body surface
- Precise and repeatable measurements thanks to a wide measuring surface
- Instant ready-to-use construction and storage bottle for long shelf life
- Non-refillable or maintenance-free structure thanks to its closed gel-filled design
- High accuracy in unknown and demanding samples thanks to its sealed special ceramic ring reference structure
- Wireless purchase option and easy cable change with connection connector (S8-BNC)
- Additional salt reserve for long service life

Stock Code	Model	Package Sizes/cm W-L-H	Packed Weight/Kg
421000150002010	ELECTRODE ORP A-S8 GLASS **	6 x 19,5 x 6	0,205
<i>There is no cable in the product. 1.5 mt and 6 mt cable options are available in the bottom line.</i>			
760204060000007	CABLE SET E COAXIAL SENSOR S8-BNC 1.5 MT	--	--
760204060000006	CABLE SET E COAXIAL SENSOR S8-BNC 6 MT	--	--

Technical Specifications

Measuring Range	-2000 mV / 2000 mV
Body Specifications	Glass / 12 mm / 120 mm / PG13.5
Max. Pressure	6 Bar
Temperature Range	0-80 °C
Min. Conductivity	100 uS
Junction No:	Single
Junction Material	Ceramic Ring
Reference Gel	Ag/AgCl
Connector	S8 / BNC
Cable Length	1.5 meter / 6 meters

ELECTRODE ORP A1M-BNC GLASS SENSOR

Single Reference ORP Sensor with Glass Body



- High chemical strength and high performance in clean water applications thanks to the glass body surface
- Precise and repeatable measurements thanks to a wide measuring surface
- Instant ready-to-use construction and storage bottle for long shelf life
- Non-refillable or maintenance-free structure thanks to its closed gel-filled design
- Accurate measurement in unknown and demanding samples thanks to sealed reference design
- Easy to use thanks to a 1-meter cable and BNC connection
- Additional salt reserve for long service life

Stock Code	Model	Package Sizes/cm W-L-H	Packed Weight/Kg
421000150100010	ORP A1M-BNC GLASS SENSOR	6 x 19,5 x 6	0,220

Technical Specifications

Measuring Range	-2000 mV / 2000 mV
Body Specifications	Glass / 12 mm / 100 mm
Max. Pressure	6 Bar
Temperature Range	0-80 °C
Min. Conductivity	100 uS
Junction No:	Single
Junction Material	Ceramic Pin
Reference Gel	Ag/AgCl
Connector	BNC
Cable Length	1 meters

ELECTRODE CONDUCTIVITY G 2CELL NTC10K AS

ABS Body Two-Cell Conductivity Sensor



- High chemical resistance with ABS body
- High measurement quality with 2-cell graphite sensor design
- Suitable cell constants for popular conductivity ranges (K:1.0, 0.1)
- Internal temperature sensor for automatic temperature compensation (NTC10K)
- Easy installation thanks to the specially designed Mic 6 connection
- Suitable for immersion, electrode housing and in-line assemblies
- 1 meter and 6-meter self-wiring models

Stock Code	Model	Package Sizes/cm W-L-H	Packed Weight/Kg
421000290102060	ELECTRODE CONDUCTIVITY GRAPHITE 2CELL CT25 EN06 MIC NTC10K K1 A51	7 x 23 x 4,5	0,130
421000290102070	ELECTRODE CONDUCTIVITY GRAPHITE 2CELL NTC10K K1 A56	9,5 x 23 x 5,5	0,195

Technical Specifications

Measuring Range	0 μ S/cm - 20.000 μ S/cm
Body Specifications	ABS
Max. Pressure	6 Bar
Temperature Range	0-80 °C
Min. Conductivity	5 μ S for K=1/0.5 μ S for K=0.1
Conductivity Sensor	Graphite
Cell Constant	K=0.1/cm - K=1/cm (+-10)
Temperature Sensor	NTC10K
Connector	MIC 6
Cable Length	1 meter / 6 meters

ELECTRODE CONDUCTIVITY G 2CELL PT1000 AS

Two-Cell Conductivity Sensor with Epoxy Body

- High chemical and physical strength with epoxy body
- High measurement quality with 2-cell graphite sensor design
- Suitable cell constants for popular conductivity ranges (K:1.0, 0.1)
- Internal temperature sensor for automatic temperature compensation (PT1000)
- Suitable for immersion, electrode housing and in-line assemblies
- 1 meter and 6-meter self-wiring models



Stock Code	Model	Package Sizes/cm W-L-H	Packed Weight/Kg
421000250101050	ELECTRODE CONDUCTIVITY GRAPHITE 2CELL PT1000K1 AS1	9,5 x 23 x 5,5	0,140
421000250601040	ELECTRODE CONDUCTIVITY GRAPHITE 2CELL PT1000K1 AS6	9,5 x 23 x 5,5	0,195
421000290101040	ELECTRODE CONDUCTIVITY GRAPHITE 2CELL PT1000K0,1 AS1	9,5 x 23 x 5,5	0,140
421000290101050	ELECTRODE CONDUCTIVITY GRAPHITE 2CELL PT1000K0,1 AS6	9,5 x 23 x 5,5	0,195

Technical Specifications

Measuring Range	0 μ S/cm - 20,000 μ S/cm
Body Specifications	Epoxy
Max. Pressure	6 Bar
Temperature Range	0-80 °C
Min. Conductivity	5 μ S for K=1/0.5 μ S for K=0.1
Conductivity Sensor	Graphite 2-cell
Cell Constant	K=0.1/cm - K=1/cm (+-10)
Temperature Sensor	PT1000
Connector	MIC 6
Cable Length	1 meter / 6 meters



ELECTRODE CONDUCTIVITY CS676HTTC SENSOR XS

Two-Cell Conductivity Sensor with Stainless Body

- Robust body design made of stainless steel and peek
- High measurement quality with 2-cell stainless steel sensor design
- High pressure and high temperature resistance (17 Bar, 200 °C)
- Suitable for heavy-duty applications such as boiler applications
- Suitable cell constants for popular conductivity ranges (K:1.0, 0.1)
- Internal temperature sensor for automatic temperature compensation (PT1000)
- Self-threaded body design for easy track mounting (3/4" NPT)
- 6 meter self-wired

Stock Code	Model	Package Sizes/cm W-L-H	Packed Weight/Kg
421000210501010	ELECTRODE CONDUCTIVITY CS676HTTC K:1 SENSOR XS	15 x 25 x 6	0,760
421000210501030	ELECTRODE CONDUCTIVITY CS676HTTC K:0.1 SENSOR XS	15 x 25 x 6	0,760

Technical Specifications

Measuring Range	0 µS/cm - 200 mS/cm
Body Specifications	SS316 and PEEK
Max. Pressure	17 Bar
Temperature Range	0-200 °C
Min. Conductivity	10 µS for K=1/1 µS for K=0.1
Conductivity Sensor	SS316 2-cell
Cell Constant	K=0.1/cm - K=1/cm (+-10)
Temperature Sensor	PT100
Connector	MIC 6
Cable Length	1 meter / 6 meters

ELECTRODE FCL SELECTIVE

Free Chlorine Sensor with Membrane Covered



- Ability to work in a wide pH range thanks to reduced pH dependence (4-9 pH)
 - High resistance to surfactants
 - New membrane design up to 3 bar
 - Ability to work at low conductivity values (Min. 10 μ S)
 - Models suitable for different chlorine measuring ranges
 - Suitable for swimming pool, drinking water, service water, process water, vegetable and fruit washing, poultry, salt water and sea water* processes
- * Ability to measure in sea water (with optional membrane)

Stock Code	Model	Package Sizes/cm W-L-H	Packed Weight/Kg
421000320101010	ELECTRODE FCL/O 2 PPM SELECTIVE	19 x 29 x 7,5	0,520
421000320101020	ELECTRODE FCL/O 5 PPM SELECTIVE	19 x 29 x 7,5	0,520
421000320101030	ELECTRODE FCL/O 200 PPM SELECTIVE	19 x 29 x 7,5	0,520

Technical Specifications

Measuring Range	0 - 200 ppm
Body Specifications	PVC
Max. Pressure	3 Bar
Temperature Range	0-45 °C
Conductivity Range	10 μ S/cm - 50 mS/cm (sea water)
Ph Range	4-9 pH
Sample Flow Rate	15-30 Lt/H
Initial Startup	2 hours (Approx.)
Connector	MIC 4
Cable Length	1.2 meter

ELECTRODE TCL SELECTIVE

Total Chlorine Sensor with Membrane Covered

- Ability to work in a wide pH range thanks to reduced pH dependence (4-9 pH)
- High resistance to surfactants
- New membrane design up to 3 bar
- Ability to work at low conductivity values (Min. 10 uS)
- Suitable for swimming pool, drinking, service, process waters, saltwater, and sea water* processes * Measuring in sea water (with optional membrane)



Stock Code	Model	Package Sizes/cm W-L-H	Packed Weight/Kg
421000420101010	ELECTRODE TCL/O 5 SELECTIVE	19 x 29 x 7,5	0,520

Technical Specifications

Measuring Range	0 - 5 ppm
Body Specifications	PVC
Max. Pressure	3 Bar
Temperature Range	0-45 °C
Conductivity Range	10 µS/cm - 200 mS/cm (Salty Water)
Ph Range	4-9 pH
Sample Flow Rate	15-30 Lt/H
Initial Startup	2 hours (Approx.)
Connector	MIC 4
Cable Length	1.2 meter

ELECTRODE CLO₂ SELECTIVE

Chlorine Dioxide Sensor with Membrane Covered

- Ability to work in a wide pH range thanks to reduced pH dependence (1-12 pH)
- New membrane design up to 1 bar
- Models with suitable ranges for different chlorine dioxide measurement ranges
- Suitable for swimming pool, drinking water, service water and process water



Stock Code	Model	Package Sizes/cm W-L-H	Packed Weight/Kg
421000520101020	ELECTRODE CLO ₂ /O 2 PPM SELECTIVE	19 x 29 x 7,5	0,520
421000520101010	ELECTRODE CLO ₂ /O 10 PPM SELECTIVE	19 x 29 x 7,5	0,520

Technical Specifications

Measuring Range	0 - 10 ppm
Body Specifications	PVC
Max. Pressure	1 Bar
Temperature Range	0-45 °C
Min. conductivity	10 µS/cm
Ph Range	1-12 pH
Sample Flow Rate	15-30 Lt/H
Initial Startup	1 hours (Approx.)
Connector	MIC 4
Cable Length	1.2 meter

ELECTRODE OZONE SELECTIVE

Ozone Sensor with Membrane Covered

- Ability to work in a wide pH range thanks to reduced pH dependence (4-9 pH)
- High resistance to surfactants
- New membrane design up to 1 bar
- Suitable for swimming pool, water treatment and all process waters



Stock Code	Model	Package Sizes/cm W-L-H	Packed Weight/Kg
421000620101010	ELECTRODE OZONE /O 2 PPM SELECTIVE	19 x 29 x 7,5	0,520
421000620101020	ELECTRODE OZONE/O 5 PPM SELECTIVE	19 x 29 x 7,5	0,520
421000620101030	ELECTRODE OZONE /O 20 PPM SELECTIVE	19 x 29 x 7,5	0,520

Technical Specifications

Measuring Range	0 - 20 ppm
Body Specifications	PVC
Max. Pressure	1 Bar
Temperature Range	0-45 °C
Min. conductivity	10 µS/cm
Ph Range	4-9 pH
Sample Flow Rate	15-30 Lt/H
Initial Startup	1 hours (Approx.)
Connector	MIC 4
Cable Length	1.2 meter

ELECTRODE H₂O₂ SELECTIVE

Hydrogen Peroxide Sensor with Membrane Covered



- Ability to work in a wide pH range thanks to reduced pH dependence (2-11 pH)
- High resistance to surfactants
- New membrane design up to 1 bar
- Models suitable for different chlorine measuring ranges
- All water treatment processes, sea water, bottle and carboy washing, CIP facilities

Stock Code	Model	Package Sizes/cm W-L-H	Packed Weight/Kg
421000720101020	ELECTRODE H2O2 / O 200 PPM SELECTIVE	19 x 29 x 7,5	0,520
421000720101010	ELECTRODE H2O2/O 500 PPM SELECTIVE	19 x 29 x 7,5	0,520

Technical Specifications

Measuring Range	0 - 500 ppm
Body Specifications	PVC
Max. Pressure	1 Bar
Temperature Range	0-45 °C
Min. conductivity	10 µS/cm
Ph Range	2-11 pH
Sample Flow Rate	15-30 Lt/H
Initial Startup	5 hours (Approx.)
Connector	MIC 4
Cable Length	1.2 meter

AMPEROMETRIC FREE CHLORINE CELL

Amperometric Copper Platinum Free Chlorine Sensor



- Acrylic body with flow indicator, resistant to corrosive chemicals
- Copper-Platin sensor structure
- Self-cleaning physical mechanism on the measurement surface
- Flow control sensor
- 2 x 12 mm sensor inputs (Optional)

Stock Code	Model	Package Sizes/cm W-L-H	Packed Weight/Kg
600510010111000	AMPEROMETRIC FREE CHLORINE CELL	21 x 24 x 10	1,75

Technical Specifications

Measuring Range	0 - 10 ppm
Body Specifications	Acrylic
Max. Pressure	3 Bar
Temperature Range	0-50 °C
Min. conductivity	10 µS/cm
Sensor	Copper-Platin
Ph Range	6-8 pH
Sample Flow Rate	50 Lt/H
Connector	BNC
Cable Length	1 meter

ELECTRODE POTENTIOSTATIC S8

Single Reference Potentiostatic FCl & ClO₂ Sensor with Glass Body

- High chemical strength and high performance thanks to the glass body surface
- Precise and repeatable measurements thanks to its wide gold measurement surface
- Minimal maintenance thanks to its design that does not require membrane and gel
- Instant ready-to-use construction and storage bottle for long shelf life
- Direct suitability for chlorine and chlorine dioxide measurements (0-10 ppm)
- Wireless purchase option and easy cable change with connection connector (S8-BNC)



Stock Code	Model	Package Sizes/cm W-L-H	Packed Weight/Kg
421002320003010	ELECTRODE POTANSIOSTATIC S8	5,5 x 4,5 x 20	0,09
<i>*** The product does not have a cable. 1.5 mt and 6 mt cable options are available in the bottom line.</i>			
760204060000007	CABLE SET E COAXIAL SENSOR S8-BNC 1.5 MT	--	--
760204060000006	CABLE SET E COAXIAL SENSOR S8-BNC 6 MT	--	--

Technical Specifications

Measuring Range	0 - 10 ppm
Body Specifications	glass
Max. Pressure	6 Bar
Temperature Range	0-80 °C
Conductivity Range	10 µS/cm - 50 mS/cm (salty water)
Sensor	Gold
Ph Range	4 - 9 pH
Sample Flow Rate	80 - 90 Lt/H
Connector	S8
Cable Length	1.2 meter

INLINE FLUOROMETER SENSOR

Inline Optical Trace Element Sensor



- PTSA or Fluorescein optical measurements with a single sensor
- Improved turbidity and dissolved iron rejection
- Solid state Fluorometer uses led/photodiode technology, does not contain moving parts
- Dynamic range : PTSA (<1 - 300 ppb), Fluorescein (<1 - 100 ppb)
- Precision: <1 ppb
- Suitable for cooling towers, boilers, leak detection, reverse osmosis, environmental monitoring processes

Stock Code	Model	Package Sizes/cm W-L-H	Packed Weight/Kg
704421000000053	STN ELECTRODE INLINE FLUOROMETER PTSA	19 x 29 x 7,5	0,520

Technical Specifications

Measuring Range	<1 - 300 ppb for PTSA
Measuring Range	<1 - 100 ppb for Fluorescein
Precision	<1 ppb
Body Specifications	PVC
Max. Pressure	6 Bar
Temperature Range	0-50 °C
Response Time	5 seconds
Sensor	Optical
Installation Connection	1" NPT
Cable Length	1.2 meter

ELECTRODE DO OPTICAL PVC B

Immersion Type Optical Dissolved Oxygen Sensor



- High chemical resistance PVC body
- Thanks to optical reading technology, it does not need liquid filling and membrane
- Internal air inlet for automatic cleaning (max 3 bar)
- Automatic compensation with internal PT 1000 temperature sensor
- Suitable for immersion type assemblies
- Compressive strength up to 1 bar (at 25 °C)
- 10 meter fixed sealed cable

Stock Code	Model	Package Sizes/cm W-L-H	Packed Weight/Kg
421000860101010	ELECTRODE DO OPTICAL PVC B	17 x 26 x 10	0,980

Technical Specifications

Measuring Range	0 - 20.00 ppm
Body Specifications	PVC-C
Max. Pressure	1 Bar
Max. Cleaning Pressure	3 Bar
Temperature Range	0-50 °C
DO Sensor	Optical
Temperature Sensor	PT1000
Mounting Type	Immersion Type
Connector	MIC 4
Cable Length	10 meter

ELEKTRODE DO OPTICAL INLINE PVC B

Inline Type Optical Dissolved Oxygen Sensor



- High chemical resistance PVC body
- Thanks to optical reading technology, it does not need liquid filling and membrane
- Automatic compensation with internal PT 1000 temperature sensor
- Suitable for on-line and housing-type installations
- Compressive strength up to 6 bar (at 25 °C)
- 10 meter fixed sealed cable

Stock Code	Model	Package Sizes/cm W-L-H	Packed Weight/Kg
421000860101020	ELEKTRODE DO OPTICAL INLINE PVC B	17 x 26 x 10	0,980

Technical Specifications

Measuring Range	0 - 20.00 ppm
Body Specifications	PVC-C
Max. Pressure	6 Bar
Temperature Range	0-50 °C
DO Sensor	Optical
Temperature Sensor	PT1000
IP Class	IP 68
Mounting Type	On-line or Housing
Connector	MIC 4
Cable Length	10 meter

ELECTRODE TU PVC B

Immersion Type Turbidity Sensor



- High chemical resistance PVC body
- Precise measurement thanks to optical reading technology
- Nephelometric measurement method in accordance with ISO 7027-EN 27027 standards (for NTU unit)
- Suitable for on-line and housing-type installations
- Compressive strength up to 1 bar (at 25 °C)
- 10 meter fixed sealed cable

Stock Code	Model	Package Sizes/cm W-L-H	Packed Weight/Kg
421001460101030	ELECTRODE TU 4/40/400 NTU PVC B	17 x 26 x 10	0,980
421001460101040	ELECTRODE TU 100/1000/10000 FTU PVC B	17 x 26 x 10	0,980

Technical Specifications

Measurement Range (NTU)	0/4,000 - 0/40,00 - 0/400,0 NTU
Measurement Range (FTU)	0/100,0 - 0/1000 - 0/10000 FTU
Body Specifications	PVC-C
Max. Pressure	1 Bar
Max. Cleaning Pressure	3 Bar
Temperature Range	0-50 °C
TU Sensor	Optical
Mounting Type	Immersion Type
Connector	MIC 4
Cable Length	10 meter

ELECTRODE TU INLINE PVC B

Inline Type Turbidity Sensor



- High chemical resistance PVC body
- Precise measurement thanks to optical reading technology
- Nephelometric measurement method in accordance with ISO 7027-EN 27027 standards (for NTU unit)
- Suitable for on-line and housing-type installations
- Compressive strength up to 6 bar (at 25 °C)
- 10 meter fixed sealed cable

Stock Code	Model	Package Sizes/cm W-L-H	Packed Weight/Kg
421001460101010	ELECTRODE TU 4/40/400 NTU INLINE PVC B	17 x 26 x 10	0,980
421001460101020	ELECTRODE TU 100/1000/10000 FTU INLINE PVC B	17 x 26 x 10	0,980

Technical Specifications

Measurement Range (NTU)	0/4,000 - 0/40.00 - 0/400.0 NTU
Measurement Range (FTU)	0/100,0 - 0/1000 - 0/10000 FTU
Body Specifications	PVC-C
Max. Pressure	6 Bar
Temperature Range	0-50 °C
TU Sensor	Optical
IP Class	IP 68
Mounting Type	On-line or Housing
Connector	MIC 4
Cable Length	10 meter



ELECTRODE TEMPERATURE NTC AS

NTC Temperature Sensor with Chrome Body

- SS316 sensor body
- Easy mounting with PG13.5 connection
- NTC 10K temperature sensor
- Suitable for on-line and housing-type installations
- Compressive strength up to 6 bar (at 25 °C)
- 1- and 6-meter sealed cable options

Stock Code	Model	Package Sizes/cm W-L-H	Packed Weight/Kg
421001150101010	ELECTRODE TEMPERATURE NTC AS1	9,5 x 23 x 5,5	0,138
421001150601020	ELECTRODE TEMPERATURE NTC AS6	9,5 x 23 x 5,5	0,250

Technical Specifications

Measuring Range	0 - 80 °C
Measuring Body	SS 316
Body Diameter	4mm
Sensor Length	108mm
Max. Pressure	6 Bar
Temperature Sensor	NTC10K
Line Connection	PG13,5
Mounting Type	On-line and Housing
Connector	MIC 6
Cable Length	1 meter / 6 meters

ELECTRODE HEAT PT100

PT100 Temperature Sensor with Chrome Body

- SS316 sensor body
- Easy installation with 1/2 connection record
- PT100 temperature sensor

Suitable for on-line and housing-type installations

Compressive strength up to 6 bar (at 25 °C)

1- and 5-meter sealed cable options



Stock Code	Model	Package Sizes/cm W-L-H	Packed Weight/Kg
421001100101010	ELECTRODE TEMPERATURE PT100 C1	9,5 x 23 x 5,5	0,200
421001100501010	ELECTRODE TEMPERATURE PT100 C5	9,5 x 23 x 5,5	0,325

Technical Specifications

Measuring Range	0 - 200 °C
Measuring Body	SS 316
Body Diameter	6mm
Sensor Length	135mm
Max. Pressure	6 Bar
Temperature Sensor	PT100
Line Connection	1/2
Mounting Type	On-line and Housing
Connector	MIC 6
Cable Length	1 meter / 5 meters

TEMPERATURE SENSOR NTC

NTC Temperature Sensor with Polypropylene Body

- Polypropylene sensor body
- Easy installation with 1/2 connection record
- NTC 10K temperature sensor
- Suitable for on-line, housing and immersion type assemblies
- Compressive strength up to 6 bar (at 25 OC)
- 1- and 5-meter sealed cable options



Stock Code	Model	Package Sizes/cm W-L-H	Packed Weight/Kg
400102000100000	SENSOR TEMPARATURE NTC P1	9,5 x 23 x 5,5	0,138
400102000500000	SENSOR TEMPARATURE NTC P5	9,5 x 23 x 5,5	0,250

Technical Specifications

Measuring Range	0 - 80 °C
Measuring Body	PP
Body Diameter	12mm
Sensor Length	80mm
Max. Pressure	6 Bar
Temperature Sensor	NTC10K
Line Connection	1/2
Mounting Type	On-line, Reservoir and Immersion
Connector	MIC 6
Cable Length	1 meter / 6 meters

CALIBRATION LIQUID PH

standard Buffer Solution for pH



- Easy to distinguish thanks to colored liquids
- Liquid transfer area for measurement thanks to specially designed bottles
- 500 ml and 20 ml options

Stock Code	Model	Package Sizes/cm W-L-H	Packed Weight/Kg
429900000040020	CALIBRATION LIQUID PH 4 20ML	3,5 x 3 x 6	0,032
429900000040480	CALIBRATION LIQUID PH 4 500ML	6 x 3 x 21,5	0,532
429900000070020	CALIBRATION LIQUID PH 7 20ML	3,5 x 3 x 6	0,032
429900000070480	CALIBRATION LIQUID PH 7 500ML	6 x 3 x 21,5	0,532
429900000100020	CALIBRATION LIQUID PH10 20ML	3,5 x 3 x 6	0,032
429900000100480	CALIBRATION LIQUID PH10 500ML	7,5 x 3 x 15,5	0,571

CALIBRATION LIQUID ORP

Standard Buffer Solution for ORP

- Easy to distinguish thanks to colored liquids
- Liquid transfer area for measurement thanks to specially designed bottles
- 500 ml and 20 ml options



Stock Code	Model	Package Sizes/cm W-L-H	Packed Weight/Kg
429901002250020	CALIBRATION LIQUID ORP 225 20ML	3,5 x 3 x 6	0,030
429901002250480	CALIBRATION LIQUID ORP 225 250ML	6 x 3 x 21,5	0,488
429901004750020	CALIBRATION LIQUID ORP 475 20ML	3,5 x 3 x 6	0,034
429901004750480	CALIBRATION LIQUID ORP 475 500ML	6 x 3 x 21,5	0,528

CALIBRATION LIQUID CON

Standard Buffer Solution for Conductivity

- Wide range of values allowing calibration in different ranges
- Liquid transfer area for measurement thanks to specially designed bottles
- 500 ml and 20 ml options



Stock Code	Model	Package Sizes/cm W-L-H	Packed Weight/Kg
429902001000020	CONDUCTIVITY SOLUTION 100US 20ML	3,5 x 3 x 6	0,031
429902001000480	CONDUCTIVITY SOLUTION 100US 500ML	6 x 3 x 21,5	0,534
429902014130020	CONDUCTIVITY SOLUTION 1413US 20ML	3,5 x 3 x 6	0,031
429902014130480	CONDUCTIVITY SOLUTION 1413US 500ML	6 x 3 x 21,5	0,534
429902027640020	CONDUCTIVITY SOLUTION 2764US 20ML	3,5 x 3 x 6	0,031
429902027640480	CONDUCTIVITY SOLUTION 2764US 500ML	6 x 3 x 21,5	0,534
429902128800020	CONDUCTIVITY SOLUTION 12880US 20ML	3,5 x 3 x 6	0,031
429902128800480	CONDUCTIVITY SOLUTION 12880US 500 ML	6 x 3 x 21,5	0,534



07 Auxiliary Equipments

AnTech has offered you interfaces and information panels from its field experiences, in product packs. They are the solutions developed for non-standard applications in product groups such as dosing pumps, controlling devices, systems and sensors.



Auxiliary Equipments

INFORMATION PANELS

Communication Led Information Panels



- It is used in every environment such as hotels, business centers, pool facilities, factories, production lines, etc. for information.
- Dot-Matrix led screen, WI-FI communication
- Connection to OmniCon control device as a direct screen
- Connection can be made to the interface with INFO PANEL P10 COMMUNICATION MODULE over wi-fi and parameters and special messages can be added manually

Stock Code	Model	Description	Packed Weight/Kg
410010031000000	INFO PANEL P10 64X32 OMNICON	64X32 64x32 Pixel Screen (53,5x30 cm - 9 cm)	7,15
410010033000000	INFO PANEL P10 128X64 OMNICON	128x64 Pixel Screen (107x60 cm - 9 cm)	14,30
410010032000000	INFO PANEL P10 COMMUNICATION MODULE	INFO PANEL Wi-fi Communication module	xx



INFO PANEL P10 COMMUNICATION MODULE

Info Panel Control and Communication Module

- Info panels communicate by telephone with Wi-fi protocols and display the information entered with the interface opened on the Panel.
- Optionally, it manually displays all parameters such as date, hour, temperature (indoor, outdoor, pool water, sea water, etc.) humidity, pH, ORP, Chloride, conductivity, Pressure, Counter, electrical values and simultaneous values.
- Special messages or parameters can be programmed in order to be displayed depending on the events. If necessary, special messages can be added and the messages are displayed together with the parameters.



SI MB HT & SI MB

Temperature and Humidity Interface

- It is used as an interface for temperature, humidity sensor connection to controllers and Information Panels.
- Prevents data loss due to distance.



Stock Code	Model	Description	Package Sizes/cm W-L-H	Packed Weight/Kg
410060020000000	SI-MB HT	Temperature - Humidity interface	12 x 21 x 13	0,245
410060010000000	SI-MB	Sensor interface	12 x 21 x 13	0,245

3L1P

3 Liquid Level Inlets, 1 Pump Outlet

- Allows three level sensors to be used in a single fluid level-controlled dosing pump. (3L1P)



Stock Code	Model	Description	Package Sizes/cm W-L-H	Packed Weight/Kg
410070020000000	3L1P	3 Level Sensor inputs + 1 Dosing Pump Output	11,5 x 15 x 10,5	0,260

1S4P

1 Counter Input, 4 Pump Outputs

- Allows multiple volumetric controlled dosing pumps to be operated with a single meter. (1S4P)



Stock Code	Model	Description	Package Sizes/cm W-L-H	Packed Weight/Kg
410070010000000	1S4P	1 Counter input + 4 Dosing Pumps Output	11,5 x 15 x 10,5	0,260

FEED DISPENSER

Feeding Dispenser

- Used to connect three pumps to a single outlet. (Supply Dispenser)



Stock Code	Model	Description	Package Sizes/cm W-L-H	Packed Weight/Kg
410070040000000	PUMP OUTPUT DISTRIBUTOR	Feeding Dispenser	21 x 24 x 18	0,685

JACO

Jacuzzi Controller

- Timed control unit for hot tub. (JACO)



Stock Code	Model	Description	Package Sizes/cm W-L-H	Packed Weight/Kg
410090010000000	JACO 1VO	Jacuzzi Controller	12 x 21 x 13	0,340

SENSOR PRE-AMP

Sensor Pre-Amplifier

- The sensor is used to extend the cable distance. (Sensor Pre-Amp)
5V DC is used with external supply.



Stock Code	Model	Description	Package Sizes/cm W-L-H	Packed Weight/Kg
410070030000000	SENSOR PRE AMP	Sensor Pre-Amplifier	12 x 21 x 13	0,255

INTERMEDIATE CABLES

Intermediate Cable Sets



- 10-meter intermediate cable from NC3-FX connector to NC3-MX connector (OmniConVisio information panel connection intermediate cable)
- Four different lengths of intermediate cable, 1, 10, 20 and 30 meters from BNC connector to BNC connector

Stock Code	Model	Cable Length
610104060000001	CABLE SET COAXIAL SENSOR BNCE BNCE 1MT	1 Meter
610104060000002	CABLE SET COAXIAL SENSOR BNCE BNCE 5MT	5 Meter
610104060000003	CABLE SET COAXIAL SENSOR BNCE BNCE 10MT	10 Meter
610104060000004	CABLE SET COAXIAL SENSOR BNCE BNCE 20MT	20 Meter
610104060000005	CABLE SET COAXIAL SENSOR BNCE BNCE 30MT	30 Meter
610103070000012	CABLE SET SIGNAL CON NC3 FX MX	10 Meter

ELECTRODE HOUSING 1 FILTERED

Filtered Electrode Housing with 12mm Sensor Inlet (1 Piece)



- Chemical and physical strength with transparent ABS body
- Quick installation thanks to easy mounting and connecting clips
- Additional mounting apparatus with intelligent design with add-on modules and structure that does not require record connections
- Structure that offers high measurement quality thanks to its sample water guided design
- Compressive strength up to 6 bar
- Easy to clean stainless steel dirt trap filter

Stock Code	Model	Description
600112511010120	ELECTRODE HOUSING 1 FILTER A	Electrode Housing Filtered With 12mm Sensor input.
600110400500010	MOUNTING SET OF ELECTRODE HOUSING 2	Connection Parts For Electrode Housing 2

ELECTRODE HOUSING 2

Electrode Housing with 12mm Sensor Inlet (2 Pieces)



- Chemical and physical strength with transparent ABS body
- Quick installation thanks to easy mounting and connecting clips
- Additional mounting apparatus with intelligent design with add-on modules and structure that does not require record connections
- Structure that offers high measurement quality thanks to its sample water guided design
- Compressive strength up to 6 bar

Stock Code	Model	Description
600112521000120	ELECTRODE HOUSING 2	Electrode Housing With 12 mm Sensor input (2 Pieces)
600110400500010	MOUNTING SET OF ELECTRODE HOUSING 2	Connection Parts For Electrode Housing

ELECTRODE HOUSING 1 FILTERED - PG13,5

Electrode Housing with Filter, PG13.5 Threaded Sensor Inlet (1 Piece)



- Chemical and physical strength with transparent ABS body
- Quick installation thanks to easy mounting and connecting clips
- Additional mounting apparatus with intelligent design with add-on modules and structure that does not require record connections
- Structure that offers high measurement quality thanks to its sample water guided design
- Compressive strength up to 6 bar
- Easy to clean stainless steel dirt trap filter

Stock Code	Model	Description
600112511010130	ELECTRODE HOUSING 1 FILTER-PG13,5 A	Pg13,5 Electrode Housing Filtered With Single Electrode input.
600110400500010	MOUNTING SET FOR ELECTRODE HOUSING 2	Connection Parts For Electrode Housing 2

ELECTRODE HOUSING 2 - PG13,5

PG13.5 Electrode Housing with Gear Sensor Inlet (2 Piece)



- Chemical and physical strength with transparent ABS body
- Quick installation thanks to easy mounting and connecting clips
- Additional mounting apparatus with intelligent design with add-on modules and structure that does not require record connections
- Structure that offers high measurement quality thanks to its sample water guided design
- Compressive strength up to 6 bar

Stock Code	Model	Description
600112521000130	ELECTRODE HOUSING 2-PG13,5	Pg13,5 Electrode Housing With Double Electrode input.
600110400500010	MOUNTING SET FOR ELECTRODE HOUSING 2	Connection Parts For Electrode Housing

ELECTRODE HOUSING 2 S272

S272 Electrode Housing with Sensor Inlet (1 Piece)



- Chemical and physical strength with transparent ABS body
- Quick installation thanks to easy mounting and connecting clips
- Additional mounting apparatus with intelligent design with add-on modules and structure that does not require record connections
- Structure that offers high measurement quality thanks to its sample water guided design
- Compressive strength up to 6 bar

Stock Code	Model	Description
600112520015000	ELECTRODE HOUSING 2-S272	S272 Electrode Housing With Single Electrode input
600110400500010	MOUNTING SET FOR ELECTRODE HOUSING 2	Connection Parts For Electrode Housing 2

ELECTRODE HOUSING 2-25MM

Electrode Housing with Ion Selective Sensor Inlet (1 Piece)



- Chemical and physical strength with transparent ABS body
- Quick installation thanks to easy mounting and connecting clips
- Additional mounting apparatus with intelligent design with add-on modules and structure that does not require record connections
- Rack that offers high measurement quality thanks to its sample water guided design
- Compressive strength up to 6 bar

Stock Code	Model	Description
600112521000250	ELECTRODE HOUSING 2-25MM	ion Selective Electrode Housing With Single Electrode input.
600110400500010	MOUNTING SET FOR ELECTRODE HOUSING 2	Connection Parts For Electrode Housing

ELECTRODE HOUSING 1

Electrode Housing with 12mm Sensor Inlet (1 Pieces)

- Chemical and physical strength with transparent ABS body
- Quick installation thanks to easy mounting and connecting clips
- Additional mounting apparatus with intelligent design with add-on modules and structure that does not require record connections
- Structure that offers high measurement quality thanks to its sample water guided design
- Compressive strength up to 6 bar



Stock Code	Model	Description
600112511000120	ELECTRODE HOUSING 1	Electrode Housing With 12 mm Sensor input.
600110400500010	MOUNTING SET FOR ELECTRODE HOUSING 2	Connection Parts For Electrode Housing 2

ELECTRODE HOUSING 1 - PG13,5

PG13.5 Electrode Housing with Gear Sensor Inlet (1 Piece)

- Chemical and physical strength with transparent ABS body
- Quick installation thanks to easy mounting and connecting clips
- Additional mounting apparatus with intelligent design with add-on modules and structure that does not require record connections
- Structure that offers high measurement quality thanks to its sample water guided design
- Compressive strength up to 6 bar



Stock Code	Model	Description
600112511000130	ELECTRODE HOUSING 1-PG13,5	Electrode Housing With 12 mm Single Electrode input.
600110400500010	MOUNTING SET FOR ELECTRODE HOUSING 2	Connection Parts For Electrode Housing

ELECTRODE HOUSING FLOW MODULE

Sample Water Flow Control Module with Signal Output, Valve



- Chemical and physical strength with transparent ABS body
- Quick installation thanks to easy mounting and connecting clips
- Additional mounting apparatus with intelligent design with add-on modules and structure that does not require record connections
- With adjustable valve, signal output for sufficient flow of sample water
- Compressive strength up to 6 bar

Stock Code	Model	Description
600112551000000	ELECTRODE HOUSING FLOW MODULE	Sample Water Flow Control Module With Signal Output, Valve. (Clamp Connected)
600112572000000	ELECTRODE HOUSING CLIP SET	4 Clips And 1 Each Of Open And Close Couplings To Join The Housing.
600112551010000	ELECTRODE HOUSING SET WITH FLOW MODULE BNC	Electrode Housing Flow Control Module. With Signal Output, Valve, Sample Water. (Bnc Connected)

ELECTRODE HOUSING CLIPS AND VALVE SETS

Auxiliary Sets for Sump Installation and Assembly



Clip Set

Valve Set

- Quick installation thanks to easy mounting and connecting clips
- Pressure-resistant water inlet outlet and sampling valves up to 6 bar

Stock Code	Model	Description
600112591000000	ELECTRODE HOUSING VALVE SET	Sample Water Input - Outlet Valve (2 Pieces) And Sampling Valve (1 Piece)
600112572000000	ELECTRODE HOUSING CLIP SET	4 Clips And 1 Each Of Open And Close Couplings To Join The Housing.



ANTI-SIPHON VALVE - MULTIFUNCTION VALVE

Using the system as Anti-Siphon and Pressure Relief (Relief Valve) function,
 Externally adjustable durable adjustment screw
 Durable, high chemical resistant PVDF body PTFE diaphragm
 Anti-Siphon Valve 1-6 Bar & Relief Valve 1-20 Bar

Use with Anti-Siphon Valve Function

Multi-function valve removes siphon effect to occur in the systems in which dosed point is located in the distance lower than the dosage pump.

Multi-function valve removes siphon effect in the systems in which powerful vacuum effect to occur in the dosage point in pressurized water lines.

It increases repeatability of chemical feeding in fixed flow rate by providing a fixed discharge pressure on the chemical feeding line.

It increases the performance of the chemical feeding systems by continuously exerting back pressure to the chemical feeding line..

Using the system with Relief Valve(Pressure Relief) Function

Multi-function valve ensures safe operation of the system by relieving high pressure wave in a manner sensitive to the pressure in the systems in which sudden pressure increases occur. Once the pressure increases for any reason whatsoever higher than the one adjusted, valve opens and relieves excess pressure and the relief valve closes when the pressure level returns to normal. This ensures that the dosage system works in a durable and good condition and adjusted stable dosage quantity is transferred. It serves as a security mechanism in order to prevent accidents or explosions in extremely high pressure systems.

Stock Code	Model	Description
410320010000000	ANTI-SIPHON VALVE (1/2) 4X6 V	Anti-Siphon Valve
410290010000000	MULTIFUNCTION VALVE	Anti-Siphon and Pressure Relief Valve (Relief Valve)

ELECTRODE HOUSING TU-DO PVC B

Electrode Housing Sets for DO and TU Sensors



- DO PVC B and TU PVC B model is suitable for dissolved oxygen and turbidity sensors
- Delivers accurate flow for high accuracy and repeatability
- It has a flow mechanism that prevents air bubbles
- The optical sensor provides a flow in front of it and cleans the sensor
- 910 model holder; PVC body, 4x6 mm hose connection, flow adjustment valve, 5-meter black hose. (For turbidity measurements under 1 NTU)
- 920 model holder; PVC body, 6x8 mm hose connection, 5-meter black hose (for turbidity measurements on 1 NTU and dissolved oxygen sensors)

Stock Code	Model	Description
421490000003100	ELECTRODE HOUSE TU 910 PVC B	Low Turbidity Electrode Housing With Pvc Body, 4X6 mm, Valve, 5M Hose
421490000003105	ELECTRODE HOUSE TU 920 PVC B	High Turbidity And Dissolved Oxygen Electrode Housing With Pvc Body, 6X8 mm, 5M Hose

ELECTRODE HOLDER INLINETU-DO PVC B

Inline T Holder for DO and TU Sensors



- Suitable for DO PVC B and TU PVC B model dissolved oxygen and turbidity sensors
- Provides accurate sensor mounting for high accuracy and repeatability
- Position the optical sensor lead in the most accurate way

Stock Code	Model	Description
421490000005100	ELECTRODE HOLDER INLINE TUDO PVC B	On-Line T Holder For Dissolved Oxygen And Turbidity Sensors

IMMERSION TYPE PROBE HOLDER

Sealed Dip Type Probe Holders



- Chemical resistant PVC body
- Design that protects the sensor cables from liquid contact
- Detachable, sealed electrode holder tips
- Design suitable for wall mounting from upper point

Stock Code	Model	Description
410030010000000	SUBMERSIBLE PROBE HOLDER	Submersible Type Probe Holder (For 12mm Sensors)
410030060000000	PROBE HOLDER 272CD	Submersible Type Probe Holder (For S272 Sensors)
410030080000000	SUBMERSIBLE PROBE HOLDER DO-TU PVC BTU	Submersible Type Probe Holder (For Pvc B Series, Do And Sensors)



08 Mixers



Mixers



SPEED-CONTROLLED MIXING INOX

Stainless Steel Shaft 300-900 d/d adjustable Mixers

- Durable and hardwearing thanks to its stainless steel shaft
- Easy installation thanks to the compatible flange for chassis and tank assembly
- Homogeneous mixture effect with special fan design
- Alternative fan, shaft and electricity supply options according to the height and volume of the chemical tank
- Fast assembly with its packaging ready for easy installation
- Easy provision and stock management thanks to its demounted shaft option

Place order for 1 set mixer as follows;

1 MIXER SPEED CONTROLLED INOX
1 MIXER SHAFT SET H**HH INOX

Stock Code	Model	Description
330003001010103	MIXER SPEED CONTROLLED 100 200 220V INOX	(Mixer motor and fan part for 1UU ve 2UU Litre vertical tanks (220V AC)
330003001010104	MIXER SPEED CONTROLLED 300 IBC 220V INOX	(Mixer motor and fan part for 300 Litre vertical tanks(220V AC)

The above products are the motor and fan part of the mixers. You can select the miles section below to complete the order.

600113610100201	MIXER MIL SET 100-IBC INOX	Mixer Shaft Set For 100 And 1000 (ibc) Liter Vertical Tanks.
600113610200201	MIXER MIL SET 200 INOX	Mixer Shaft Set For 200 Liter Vertical Tanks
600113610300201	MIXER MIL SET 300 INOX	Mixer Shaft Set For 300 Liter Vertical Tanks

Technical Specifications

For Motor/Fan	<input type="checkbox"/>	100-200 220V	100-200 220V	300-IBC 220V
Engine Power	KW	0,25	0,25	0,25
Supply Voltage	AC	220V	220V	220V
Revolutions per minute	RPM	1500	1500	1500
Fan Housing		SS316	SS316	SS316
Fan Diameter	mm	90	90	130
Fan Length	mm	42	42	42

For Shaft	<input type="checkbox"/>	100-IBC	200	300
Shaft Lengthl	mm	750	850	1050
Shaft Bodyl		SS316	SS316	SS316
Mixing Volume	Liters	100-1000 (IBC)	200	300



SPEED-CONTROLLED MIXING PVC

PVC Shaft 300-900 d/d adjustable Mixers

- Ability to adjust the number of revolutions between 300-900 by frequency control
 - Hardwearing and resistant to the abrasive chemicals thanks to its PVC shaft structure
 - Easy installation thanks to the compatible flange for chassis and tank assembly
 - Homogeneous mixture effect with special fan design
 - Alternative fan, shaft and electricity supply options according to the height and volume of the chemical tank
 - Fast assembly with its packaging ready for easy installation
- Easy provision and stock management thanks to its demounted shaft option

Place order for 1 set mixer as follows;

1 MIXER SPEED CONTROLLED.*|| ...* PVC
1 MIXER SHAFT SET H*L ...** PVC

Stock Code	Model	Description
330003001010101	MIXER SPEED CONTROLLED 100 200 220V PVC	(Mixer motor and fan part for 1UU ve 2UU Litre vertical tanks (220V AC)
330003001010102	MIXER SPEED CONTROLLED 300 IBC 220V PVC	(Mixer motor and fan part for 300 Litre vertical tanks (220V AC)

The above products are the motor and fan part of the mixers. You can select the miles section below to complete the order:

600113610100101	MIXER MIL SET 100-IBC PVC	Mixer Shaft Set For 100 And 1000 (IBC) Liter Vertical Tanks.
600113610200101	MIXER MIL SET 200 PVC	Mixer Shaft Set For 200 Liter Vertical Tanks
600113610300101	MIXER MIL SET 300 PVC	Mixer Shaft Set For 300 Liter Vertical Tanks

Technical Specifications

For Motor/Fan		*	100-200 220V	100-200 220V	300-IBC 220V
Engine Power	KW		0,25	0,25	0,25
Supply Voltage	AC		220V	220V	220V
Revolutions per minute	RPM		1500	1500	1500
Fan Housing			PVC	PVC	PVC
Fan Diameter	mm		90	90	130
Fan Length	mm		60	60	68

For Shaft		**	100-IBC	200	300
Shaft Length	mm		750	850	1050
Shaft Body			PVC	PVC	PVC
Mixing Volume	Liters		100-1000 (IBC)	200	300



MIXER SLOW INOX

Stainless Steel Shaft 96rpm Slow Mixers

- Robust and long-lasting with stainless steel shaft structure
- Ease of installation thanks to compatible flange for chassis and tank mounting
- Homogeneous mixing effect with special fan design
- Alternative fan, shaft, and electrical supply options according to chemical tank length and volume
- Quick mounting with easy installation ready packing
- Optional frequency-controlled motor drives with adjustable revolutions
- Easy supply and stock management thanks to the disassembled shaft option

Order 1 set of mixers as follows;

1 x MIXER SLOW INOX

1 x MIXER SHAFT SET INOX

Stock Code	Model	Description
331002000201030	MIXER SLOW 100-200-300-IBC 220V INOX	Mixer Motor And Fan Part (220V Ac) For 100 - 200 - 300 And 1000 (ibc) Liter Vertical Tanks
331002000200030	MIXER SLOW 100-200-300-IBC 380V INOX	Mixer Motor And Fan Part (380V Ac) For 100 - 200 - 300 And 1000 (ibc) Liter Vertical Tanks
<i>The above products are the motor and fan part of the mixers. You can select the miles section below to complete the order.</i>		
600113610100201	MIXER MIL SET 100-IBC INOX	Mixer Shaft Set For 100 And 1000 (ibc) Liter Vertical Tanks.
600113610200201	MIXER MIL SET 200 INOX	Mixer Shaft Set For 200 Liter Vertical Tanks
600113610300201	MIXER MIL SET 300 INOX	Mixer Shaft Set For 300 Liter Vertical Tanks

Technical Specifications

For Motor/Fan	<input type="checkbox"/>	100-200-300-IBC	100-200-300-IBC
		220V	380V
Engine Power	KW	0,18	0,18
Supply Voltage	AC	220V	380V
Revolutions per minute	RPM	96	96
Fan Housing		SS316	SS316
Fan Diameter	mm	200	200
Fan Length	mm	64	64

For Shaft	<input type="checkbox"/>	100-IBC	200	300
		Shaft Length	mm	750
Shaft Body		SS316	SS316	SS316
Mixing Volume	Liters	100-1000 (IBC)	200	300



MIXER SLOW PVC

PVC Shaft 96 rpm Slow Mixers

- Resistant to corrosive chemicals with PVC shaft structure and long life
- Ease of installation thanks to compatible flange for chassis and tank mounting
- Homogeneous mixing effect with special fan design
- Alternative fan, shaft, and electrical supply options according to chemical tank length and volume
- Quick mounting with easy installation ready packing
- Optional frequency-controlled motor drives with adjustable revolutions

Easy supply and stock management thanks to the disassembled shaft option

Order 1 set of mixers as follows;

- 1 x MIXER SLOW PVC
- 1 x MIXER SHAFT SET PVC

Stock Code	Model	Description
330002000201030	MIXER SLOW 100-200-300-IBC 220V PVC	Mixer Motor And Fan Part (220V Ac) For 100 - 200 - 300 And 1000 (IBC) Liter Vertical Tanks
330002000200030	MIXER SLOW 100-200-300-IBC 380V PVC	Mixer Motor And Fan Part (380V Ac) For 100-200- 300 And 1000 (IBC) Liter Vertical Tanks

The above products are the motor and fan part of the mixers. You can select the shaft section below to complete the order.

600113610100101	MIXER MIL SET 100-IBC PVC	Mixer Shaft Set For 100 And 1000 (IBC) Liter Vertical Tanks.
600113610200101	MIXER MIL SET 200 PVC	Mixer Shaft Set For 200 Liter Vertical Tanks
600113610300101	MIXER MIL SET 300 PVC	Mixer Shaft Set For 300 Liter Vertical Tanks

Technical Specifications

For Motor/Fan		<input type="checkbox"/> → 100-200-300-IBC	
		220V	380V
Engine Power	KW	0,18	0,18
Supply Voltage	AC	220V	380V
Revolutions per minute	RPM	96	96
Fan Housing		PVC	PVC
Fan Diameter	mm	200	200
Fan Length	mm	50	50

For Shaft		<input type="checkbox"/> → 100-IBC 200 300		
		Shaft Length	mm	750
Shaft Body		PVC	PVC	PVC
Mixing Volume	Liters	100-1000 (IBC)	200	300

CHEMICAL SUBSTANCE TANKS

Monoblock Polyethylene Chemical Tanks



- Polyethylene body resistant to acids and other chemicals One-piece monoblock structure without rivets
- UV-stabilized, solar-resistant, microorganism growth-preventing material and production technology

Stock Code	Model	Description	Body Dia. cm	Height cm	Cover Dia. cm
421510410900120	KL 100 LT CHEMICAL TANK	Monoblock Polyethylene 100 Lt Chemical Tank	41	90	12
421510501010120	KL 200 LT CHEMICAL TANK	Monoblock Polyethylene 200 Lt Chemical Tank	50	101	12
421510581190120	KL 300 LT CHEMICAL TANK	Monoblock Polyethylene 300 Lt Chemical Tank	58	119	12

TANKS WITH MIXERS

Fittings for Installing Mixers in Tanks



- The desired mixer can be installed in KL 100, KL 200, KL 300, and IBC chemical tanks.
- Prices do not include tanks and mixers; they are for installation equipment only.

Stock Code	Model	Description
600110400600000	MOUNTING SET OF MIXER 100 MOUNTING SET SPEED	Pvc Stand And Connection Parts For Mixer installation in 100 Liter Tanks
600110400600010	MOUNTING SET OF MIXER 200 MOUNTING SET SPEED	Pvc Stand And Connection Parts For Mixer installation in 200 Liter Tanks
600110400600020	MOUNTING SET OF MIXER 300 MOUNTING SET SPEED	Pvc Stand And Connection Parts For Mixer installation in 300 Liter Tanks
600110400601000	MOUNTING SET OF MIXER 100 MOUNTING SET SLOW	Pvc Stand And Connection Parts For Mixer installation in 100 Liter Tanks
600110400601010	MOUNTING SET OF MIXER 200 MOUNTING SET SLOW	Pvc Stand And Connection Parts For Mixer installation in 200 Liter Tanks
600110400601020	MOUNTING SET OF MIXER 300 MOUNTING SET SLOW	Pvc Stand And Connection Parts For Mixer installation in 300 Liter Tanks
600110400600030	MOUNTING SET OF MIXER IBC MOUNTING SET	Portable Metal Stand And Connection Parts For Mixer installation in ibc (1000 L) Tanks.



09 Waters Meters

Liquid meters are indispensable instruments of the industry. Meters used to measure the total and instantaneous flows of liquids are the most practical, most economical and healthy solution for this process.

Used in oil, chemical, petrochemical, water, wastewater, food, dye, cosmetics, pharmaceutical, automotive, construction, textile and all other industrial plants using liquids, counters prevent time, labor and cost losses and ensure accurate cost calculations and improvement of production quality.

Liquids must be measured to enable complete control in plants using water, fuel products, solvents, acids, oils, liquid food and other industrial liquids.

Water meters are the most important instruments for municipal and irrigation applications with models with a pulse output, automation applications in plants, treatment systems, and measuring and dosing applications as well as for measurement of liquids. AnTech offers the most appropriate solution for your applications with liquid meters.



Waters Meters

SINGLE JET COLD WATER METERS WITH PULSER DRY TYPE

Single Jet Cold Waters



- CD-type water meters are MID-approved according to Directive 2004/22/EC.
- Non-misting, clear and easy-to-read instrument panel.
- Tempered top glass made of suitable thickness.
- Robust and durable structure that can be used even in dirty waters.
- Special epoxy painted brass body.
- The nominal operating pressure is 16 bar.
- Internal wet parts resistant to lime and abrasion.
- Precise measuring range and low-pressure loss with single jet design.
- Thanks to the mechanical transmission system, it is not affected by external magnetic fields.
- Sealed recording mechanism with ID code and serial numbers.
- Easy installation with Horizontal and Vertical Mounting feature.
- Reed switch with IP68 protection class,

Stock Code	Model	Package Sizes/cm W-L-H	Packed Weight/Kg
421100110015000	WATER METER CD15	13,5 x 13,5 x 17,5	1,20
421100110020000	WATER METER CD20	14 x 14 x 17,5	1,37

Technical Specifications

Metrological Class MID	R(Q3 / Q1 < 250 H - < 100 V
Body Specifications	Brass Cast Body
Nominal Operating Pressure	16 Bar
Temperature Range	0-50 °C
maximum error rate	< 30 °C with +/-2% water temperature
Flow Profile Sensitivity	U0-D0 (no straight lengths required up or down)
Maximum Reading (m³)	100.000
Minimum Reading (Liters)	0.05
Pulse Options (Pulse-Liter)	1-1 / 1-10
Pulse Cable Length	1 meter
Flow rate m³ / h	DN15 -2,5 m³ / DN25-4m³ / DN35-6,3 m³

MULTI JET COLD WATER METER WITH PULSER DRY TYPE

Multi Jet Cold Water Counters



- DS-type water meters are MID-approved according to Directive 2004/22/EC.
- Non-misting, clear and easy-to-read instrument panel.
- Tempered top glass made of suitable thickness.
- Robust and durable structure that can be used even in dirty waters.
- Special epoxy painted brass body.
- The nominal operating pressure is 16 bar.
- Internal wet parts resistant to lime and abrasion.
- Inlet strainer feature with large strainer area
- Possibility of assembly without flat pipe distance (UO DO)
- Sealed recording mechanism with MID code and serial numbers.
- It is mounted horizontally and does not require a straight pipe connection, making it easy to install.
- Reed switch with IP68 protection class.

Stock Code	Model	Package Sizes/cm W-L-H	Packed Weight/Kg
421103162015000	WATER METER MJSDC15	19,5 x 19,5 x 13,5	1,80
421103162020000	WATER METER MJSDC20	20 x 20 x 13,5	2,20
421103162025000	WATER METER MJSDC25	26,5 x 26,5 x 15,5	2,90
421103162030000	WATER METER MJSDC30	26,5 x 26,5 x 15,5	3,00
421103162040000	WATER METER MJSDC40	31 x 31 x 17,5	5,10
421103162050000	WATER METER MJSDC50	32 x 32 x 18,5	10,20
421103162500000	WATER METER MJSDC50FL	32 x 32 x 18,5	10,20

Technical Specifications

Metrological Class MID	R (Q3 / Q1 < 200 H - < 50 V
Body Specifications	Brass Cast Body
Nominal Operating Pressure	16 Bar
Temperature Range	0-50 °C
Maximum error rate	< 30 °C with +/-2% water temperature
Flow Profile Sensitivity	UO-DO (no straight lengths required up or down)
Maximum Reading (m3)	100.000 (DN 15-20-25-30) / 1.000.000 (DN 40-50)
Minimum Reading (Liters)	0.05
Pulse Options (Pulse-Liter)	1-1 / 1-10 / 1-100 / 1-1000
Pulse Cable Length	1 meter
Flow rate m3 / h	DN15-2,5m3 / DN20-4m3 / DN25-6,3 m3 / DN30-10m3 / DN40-16m3 / DN50-25m3

WOLTMANN COLD WATER METERS WITH PULSER DRY TYPE

Woltmann Cold Water Counters



- WP SDC type water meters are MID-approved.
- Non-misting, clear and easy-to-read instrument panel.
- Low initial flow rate and wide measuring range.
- Design that can be installed/replaced without removing the seal.
- Epoxy painted body anti-rust according to drinking water regulations.
- Reading convenience thanks to 360° rotatable numerator.
- The nominal operating pressure is 16 bar.
- Woltman type design suitable for industrial use.
- Numerator with protection class P68
- Easy installation with horizontal and vertical connection to the pipeline.
- Reed switch with IP68 protection class,

Stock Code	Model	Package Sizes/cm W-L-H	Packed Weight/Kg
421100130050000	WATER METER WPSCD50	21 x 21 x 27	13,00
421100130065000	WATER METER WPSCD65	21 x 21 x 27	14,00
421100130080000	WATER METER WPSCD80	22,5 x 22,5 x 28,5	17,00
421100130100000	WATER METER WPSCD100	27 x 27 x 29,5	19,00
421100130125000	WATER METER WPSCD125	27 x 27 x 29,5	21,00
421100130150000	WATER METER WPSCD150	32 x 32 x 39,5	45,00
421100130200000	WATER METER WPSCD 200	36 x 36 x 41	66,00

Technical Specifications

Metrological Class MID	R80
Body Specifications	anti-rust epoxy painted body.
Nominal Operating Pressure	16 Bar
Temperature Range	0-50 °C
maximum error rate	< 30 °C with 1 +/-2% water temperature
Mounting Position	Horizontal / Vertical (H,V)
Maximum Reading (m3)	999.999,999 (DN 50-65-80-100-125) / 9.999.999,99 (DN 150-200)
Minimum Reading (Liters)	0,0005 (DN 50-65-80-100-125) / 0.005 (DN 150-200)
Pulse Options (Pulse-Liter)	1-100 / 1-1000 (DN 50-65-80-100-125) / 1-1000 / 10.000 (DN 150-200)
Pulse Cable Length	1 meter
Flow rate m3 / h	DN50-40m3 / DN65-63m3 / DN80-63 m3 / DN100-100m3 / DN125-160m3 / DN150-250m3 / DN200-400m3

WOLTMANN COLD WATER WITH PULSER

Woltmann Cold Water Counters



- MWN type water meters are mid approved in accordance with Directive 2004/22/EC.
- Non-misting, clear and easy-to-read instrument panel.
- Low initial flow rate and wide measuring range.
- Design that can be installed/replaced without removing the seal.
- Epoxy painted body anti-rust according to drinking water regulations.
- Reading convenience thanks to 3600 rotatable numerator.
- The nominal operating pressure is 16 bar.
- Next-generation woltmann design with replaceable mechanism
- Magnetic transfer and airtight indicator
- Easy installation with no flat pipe connection required mounting possibility (UO DO)
- Reed switch with IP68 protection class.

Stock Code	Model	Package Sizes/cm W-L-H	Packed Weight/Kg
421100140040000	WATER METER MWN40	21 x 21 x 18,5	8,75
421100140050000	WATER METER MWN50	21 x 21 x 19,5	10,80
421100140065000	WATER METER MWN65	22 x 22 x 20,5	11,55
421100140080000	WATER METER MWN80	22,5 x 22,5 x 2,5	14,65
421100140100000	WATER METER MWN100	26 x 26 x 23,5	16,80
421100140125000	WATER METER MWN125	26 x 26 x 23,5	19,10
421100140150000	WATER METER MWN150	31 x 31 x 36	40,90
421100140200000	WATER METER MWN200	36 x 36 x 39	53,50

Technical Specifications

Metrological Class MID	R100 (DN40-50) / R125 (DN65) / R160 (DN80)/ R200 (DN100) / R160 (DN125) / R200 (DN150) / R125 (DN200)
Body Specifications	anti-rust epoxy painted body.
Nominal Operating Pressure	16 Bar
Temperature Range	0-50 °C
maximum error rate	< 30 °C with +/-2% water temperature
Mounting Position	Horizontal / Vertical (H,V)
Flow Profile Sensitivity	"UO-DO (no straight lengths up or down)"
Maximum Reading (m³)	1.000.000(DN 40-50-65-80-100-125) /10.000.000 (DN 150-200)
Minimum Reading (Liters)	0.0005 (DN 40-50-65-80-100-125) / 0.005 (DN 150-200)
Pulse Options (Pulse-Liter)	1-10/ 1-100 / 1-1000 (DN 40-50-65-80-100-125) / 1-1000 /(DN 150-200)
Pulse Cable Length	1.5 meter
Flow rate m³ / h	DN40-30m³ / DN50-50m³ / DN65-60m³ / DN80-120m³ / DN100-230m³ / DN125-250m³ / DN150-400m³ /DN200 750 m³

10 Blowers

Blowers are the products that transfer air to low pressures or can make vacuum. It consists of a propeller and cover with a peripheral channel in it. Blower blades operate without contacting the pump housing and each other. Therefore, the blades do not need to be lubricated. The operation of the system only with air or gas ensures that the environment remains clean. Thus, it provides great advantages in chemical applications requiring a clean gas flow, aquaculture, pneumatic conveying applications, mining and wastewater treatment industries and Jacuzzi and pool applications.

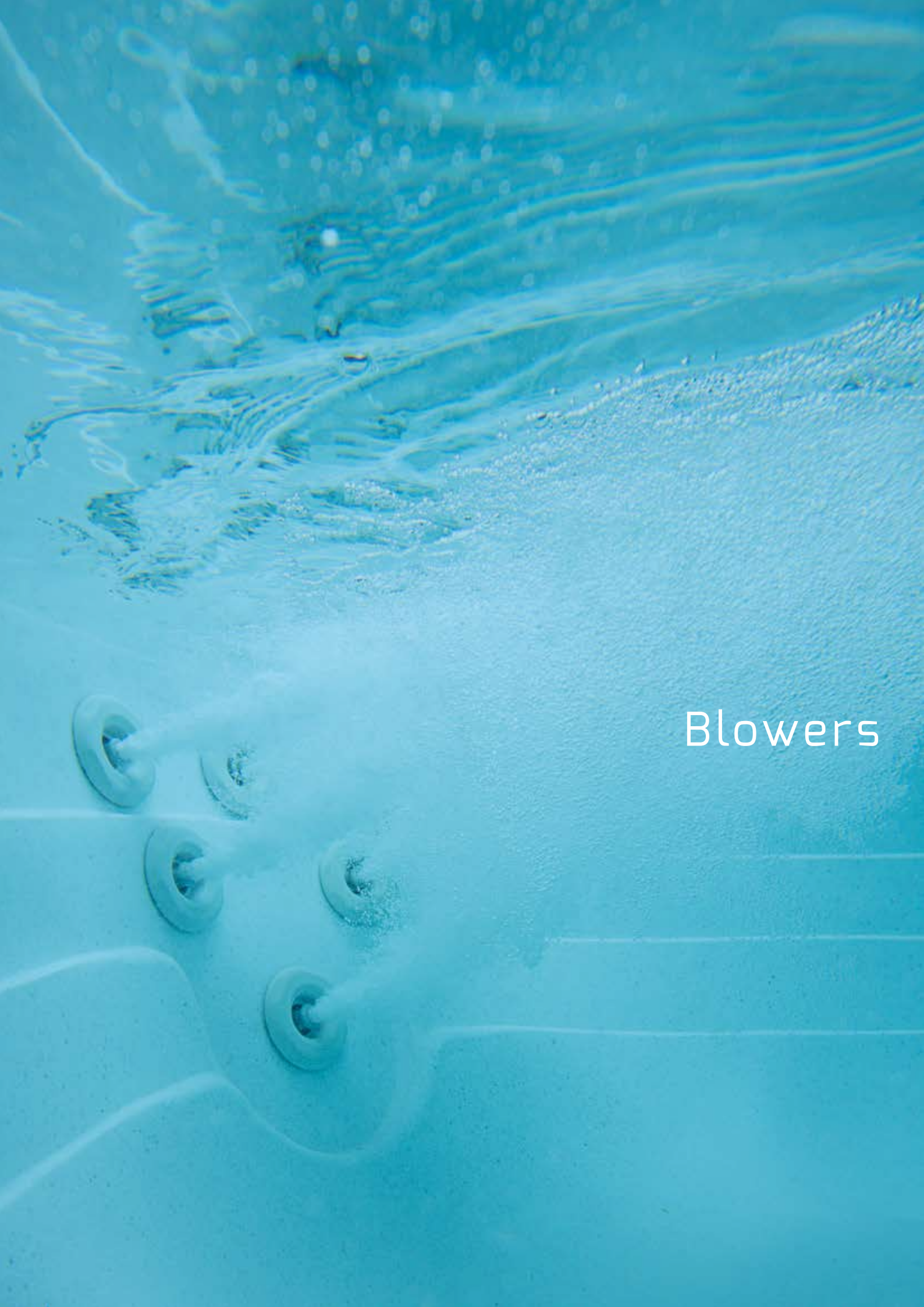

Blowers

SINGLE-STAGE BLOWERS

Single-Stage Blowers



- Minimal vibration with strong compensation
- Easy and flexible installation and use thanks to its horizontal and vertical mountable design
- High durability and long-term performance with special Aluminum body
- Maintenance-free, high-efficiency fan
- Possibility of use as pressure and vacuum blower
- Easy switching between high pressure and high vacuum
- Direct 380V AC supply (contact with us for 220 AC models)
- IP-55 body protected against water spray and dust
- Ability to work with ambient conditions at (-)10 °C and (+)50 °C
- Pulsation-free air production with low noise levels and minimal vibration operation

Stock Code	Model	Power Kw	Phase	Input-output	Packaging Dimensions / mm W-L-H	Packed Weight/Kg
421030000750000	BLOWER 0,85KW 3P	0,85	3	1 1/2"	292 x 286 x 302	16
421030101100000	BLOWER 1,1KW 1P	1,1	1	1 1/2"	292 x 286 x 302	17
421030001300000	BLOWER 1,3KW 3P	1,3	3	1 1/2"	292 x 286 x 302	17
421030001601000	BLOWER 1,6KW	1,6	3	2"	346 x 334 x 337	23
421030002201000	BLOWER 2,2KW 3P	2,2	3	2"	346 x 334 x 337	25
421030003001000	BLOWER 3KW 3P	3	3	2"	385 x 360 x 366	34
421030004001000	BLOWER 4KW 3P	4	3	2"	432 x 382 x 384	40
421030005501000	BLOWER 5,5KW 3P	5,5	3	2 1/2"	477 x 451 x 509	63
421030007501000	BLOWER 7,5KW 3P	7,5	3	2 1/2"	477 x 451 x 509	66
421030011001000	BLOWER 11KW 3P	11	3	4"	644 x 550 x 624	116
421030015001000	BLOWER 15KW 3P	15	3	4"	644 x 550 x 624	116
421030018502000	BLOWER 18,5KW 3P	18,5	3	4"	644 x 550 x 624	126



SINGLE-STAGE BLOWER SPECIFICATIONS

Model	0	50	90	100	120	130	150	160	190	200	250	270	280	300	350	360	400	430	450	460
BLOWER 0,85KW 3P	145	110	86	80	70	64	52	44												
BLOWER 1,1KW 1P	148	110	86	80	70	64	52	44	30	24										
BLOWER 1,3KW 3P	148	110	86	80	70	64	52	44	30	24										
BLOWER 1,6KW	210	180	156	148	132	125	110	102	88											
BLOWER 2,2KW 3P	210	180	156	148	132	125	110	102	88	82	54	46								
BLOWER 3KW 3P	275	240	206	200	181	177	158	150	122	118	76	60	50							
BLOWER 4KW 3P	320	276	242	238	230	224	202	198	180	176	140	124	118	100	75	72				
BLOWER 5,5KW 3P	530	480	436	430	412	406	400	396	370	358	300	286	276	258						
BLOWER 7,5KW 3P	530	480	436	430	412	406	400	396	370	358	300	286	276	258	212	200	176	150		
BLOWER 11KW 3P	1050	975	930	920	900	880	860	840	800	790	725									
BLOWER 15KW 3P	1050	975	945	920	900	880	860	840	800	790	725	695	685	660	595	560	535			
BLOWER 18,5KW 3P	1050	975	945	920	900	880	860	840	800	790	725	695	685	660	595	560	535	495	465	450

Spare Parts - Options

Stock Code	Stock Name	Description	Included in Package
42149000004200	BLOWER INJECTION SET 1 1/2"	Injection Set (Outlet Pipe, Flexible Connection, Manometer, Check Valve, Connecting Pipe, Vibration Mount)	✗
42149000004300	BLOWER INJECTION SET 2"	Injection Set (Outlet Pipe, Flexible Connection, Manometer, Check Valve, Connecting Pipe, Vibration Mount)	✗
42149000004400	BLOWER INJECTION SET 2 1/2"	Injection Set (Outlet Pipe, Flexible Connection, Manometer, Check Valve, Connecting Pipe, Vibration Mount)	✗
600112301000000	BLOWER SUCTION SET 90' (1 1/2)	Suction Set For Blower 1 1/2"	✗
600112302000000	BLOWER SUCTION SET 2"	Suction Set For Blower 2"	✗
42149000004500	BLOWER SUCTION SET 2 1/2"	Suction Set For Blower 2 1/2"	✗
42149000002900	BLOWER SUCTION SET 4	Suction Set For Blower 4	✗
42149000003700	BLOWER MUFFLER 1 1/2"	Blower Muffler 1 1/2"	✗
42149000003800	BLOWER MUFFLER 2"	Blower Muffler 2"	✗



DOUBLE-STAGE BLOWERS

DOUBLE-Stage Blowers

- Minimal vibration with strong compensation
- Easy and flexible installation and use thanks to its horizontal and vertical mountable design
- High durability and long-term performance with special Aluminum body
- Maintenance-free, high-efficiency fan
- Possibility of use as pressure and vacuum blower
- Easy switching between high pressure and high vacuum
- Direct 380V AC supply (contact with us for 220 AC models)
- IP-55 body protected against water spray and dust
- Ability to work with (-)10 OC in ambient conditions at (+) 50 OC
- Pulsation-free air production with low noise levels and minimal vibration operation

Stock Code	Model	Power Kw	Phase	Input-output	Packaging Dimensions / mm W-L-H	Packed Weight/Kg
421030002201001	BLOWER 2,2KW 3P DOUBLE STAGE	2,2	3	1½"	401 x 485 x 315	27
421031003001000	BLOWER 3KW 3P DOUBLE STAGE	3	3	2"	465 x 597 x 371	40
421030004001001	BLOWER 4KW 3P DOUBLE STAGE	4	3	2"	499 x 597 x 371	44
421030004001005	BLOWER 4,3KW 3P DOUBLE STAGE	4	3	2"	526 x 639 x 410	54
421031005501000	BLOWER 5,5KW 3P DOUBLE STAGE	5,5	3	2"	556 x 639 x 410	66
421030007501001	BLOWER 7,5KW 3P DOUBLE STAGE	7,5	3	2"	571 x 639 x 410	73
421030007501005	BLOWER 7,5KW 3P DOUBLE STAGE-H	7,5	3	2½"	589 x 799 x 509	86
421030011001001	BLOWER 11KW 3P DOUBLE STAGE	11	3	2½"	694 x 799 x 509	104
421030015001001	BLOWER 15KW 3P DOUBLE STAGE	15	3	2½"	694 x 799 x 509	120



DOUBLE-STAGE BLOWER SPECIFICATIONS

Model	0	50	100	150	200	240	250	260	280	300	350	370	380	400	440	450	460	500	570	600	670
BLOWER 2,2KW 3P DOUBLE STAGE	150	138	125	114	100	86	84	82	78	70	55	51	48	40	20						
BLOWER 3KW 3P DOUBLE STAGE	230	218	196	180	165	150	146	142	132	125	110	104	100	90							
BLOWER 4KW 3P DOUBLE STAGE	230	218	196	180	165	150	146	142	132	125	110	104	100	90	75	72	68	25			
BLOWER 4,3KW 3P DOUBLE STAGE	320	305	285	274	266	255	252	250	242	238	220	214	210								
BLOWER 5,5KW 3P DOUBLE STAGE	320	305	285	274	266	255	252	250	242	238	220	214	210	200	188	182	180	160			
BLOWER 7,5KW 3P DOUBLE STAGE	320	305	285	274	266	255	252	250	242	238	220	214	210	200	188	182	180	160	134	115	
BLOWER 7,5KW 3P DOUBLE STAGE-H	520	500	480	440	412	396	394	390	382	366	352	347	344	335							
BLOWER 11KW 3P DOUBLE STAGE	520	500	480	440	412	396	394	390	382	366	352	347	344	335	310	305	300	290	276	230	210
BLOWER 15KW 3P DOUBLE STAGE	520	500	480	440	412	396	394	390	382	510	452	424	344	335	310	305	300	290	276	265	250

Spare Parts - Options

Stock Code	Stock Name	Description	Included in Package
421490000004200	BLOWER INJECTION SET 1 1/2"	Injection Set (Outlet Pipe, Flexible Connection, Manometer, Check Valve, Connecting Pipe, Vibration Mount)	✗
421490000004300	BLOWER INJECTION SET 2"	Injection Set (Outlet Pipe, Flexible Connection, Manometer, Check Valve, Connecting Pipe, Vibration Mount)	✗
421490000004400	BLOWER INJECTION SET 2 1/2"	Injection Set (Outlet Pipe, Flexible Connection, Manometer, Check Valve, Connecting Pipe, Vibration Mount)	✗
600112301000000	BLOWER SUCTION SET 90° (1 1/2)	Suction Set For Blower 1 1/2"	✗
600112302000000	BLOWER SUCTION SET 2"	Suction Set For Blower 2"	✗
421490000004500	BLOWER SUCTION SET 2 1/2"	Suction Set For Blower 2 1/2"	✗
421490000002900	BLOWER SUCTION SET 4	Suction Set For Blower 4	✗
421490000003700	BLOWER MUFFLER 1 1/2"	Blower Muffler 1 1/2"	✗
421490000003800	BLOWER MUFFLER 2"	Blower Muffler 2"	✗

11

Portable Devices and Test Kits

Field analyses are usually carried out in order to analyze the current state of the system or to examine the water quality. In these analyzes, high precision, high accuracy, suitable measuring range and repeatability are very critical. Our AnTech experts have created the most appropriate field analysis family for you. We have products which can respond to tens of parameters as well as Ph, Orp, Conductivity, TDS, Salinity, Free Chlorine, Total Chlorine, Alkalinity, Cyanuric Acid, Iron, Nitrite, Nitrate, Total Hardness.

A person wearing a white lab coat is holding a test tube. Inside the test tube, there is a small, white, cylindrical portable device. The person's hands are visible, and the background is a solid blue color. The text "Portable Devices And Test Kits" is overlaid on the right side of the image.

Portable Devices And Test Kits

ECO TESTR PH2 WATERPROOF

Pocket-Size pH Meter



- pH measuring range 0.0 to 14.00, 0.1 resolution, ± 0.1 precision.
- Automatic calibration & automatic fluid recognition, Automatic temperature compensation (ATC)
- Waterproof IP67 floatable body
- Long sensor life without replacement
- Hold function button that temporarily freezes the reading value for easy recording
- Sensor protective cover that can be used as a reservoir for calibration liquid and sample liquid

Stock Code	Model	Package Sizes/cm W-L-H	Packed Weight/Kg
421020050000000	ECO TESTR PH2 WATERPROOF	13,5 x 24,5 x 3	0,145

Technical Specifications

Ph Measurement Range	pH 0.0 to 14.0
Precision	0.1 pH
Accuracy	± 0.1 pH
Calibration	Automatic 3 Point (pH 4 - pH 7 - pH 10)
Temperature Compensation	Automatic Temperature Compensation
Operating Temperature	0 to 50 ° C
Hold Function	Holding the last value on the screen with the hold key
Automatic shutdown	8.5 Minutes After Last Key Pressed
Body	Lcd Display / IP 67 Waterproof Case
Need for Power	4 X 1.5V "A76" Micro Alkaline Batteries

PH TESTR 30 EUTECH

Replaceable Sensor Pocket-Size pH Meter



- pH measuring range -1.0 to 15.00, 0.01 resolution, ± 0.01 precision.
- Automatic calibration & automatic fluid recognition, Automatic temperature compensation (ATC)
- Waterproof IP67 floatable body
- Easily interchangeable sensor
- Hold button that temporarily freezes the reading value for easy recording
- Sensor protective cover that can be used as a reservoir for calibration liquid and sample liquid

Stock Code	Model	Package Sizes/cm W-L-H	Packed Weight/Kg
421021090000000	PH TESTR 30 EUTECH	6,5 x 21 x 4,5	0,205

Technical Specifications

Ph Measurement Range	pH -1.0 to 15.0
Ph Sensitivity	0.01 pH
Accuracy	± 0.01 pH
Temperature Indicator / ATC	0 - 50 ° C or 32 - 122 ° F / Yes
Temperature Sensitivity	0.1 ° C / ° F
Accuracy	0.5 ° C / 0.9 ° F
Ph Buffer Options	pH 4.00, pH 7.00, pH 10.00
Automatic shutdown	8.5 Minutes After Pressing the Last Key
Special Functions/HOLD	Self-Diagnosis / Measurement Hold Function
Power Requirement	4 x 1.5V Alkaline Button Batteries



PH5 + CASE

Purse pH Meter

- 0.0 to 14.00 pH measuring range, 0.01 pH and ± 0.5 °C precision.
- Automatic calibration fluid recognition
- Automatic temperature compensation (ATC)
- Easily interchangeable external sensor
- Hold function button for easy access to reference measuring points
- Auto-off saves energy and extends battery life.

Stock Code	Model	Package Sizes/cm W-L-H	Packed Weight/Kg
421021100000000	PH5+ WITH BAG	27 x 35,5 x 8,5	1,475

Technical Specifications

Ph Measurement Range	pH 0.00 to 14.00
Ph Precision and Accuracy	0.01 pH and ± 0.01 pH
Temperature Range	0 to 100.0 °C
Temperature Sensitivity and Accuracy	0.1 °C and ± 0.5 °C
Temperature Compensation	Auto / Manual (0 to 100 °C)
Ph Buffer Options	pH 4.00, pH 7.00, pH 10.00
Special Functions	Auto-Off after 17 minutes a/ Self-diagnostic messages
Power Requirement	4 'AAA' x 1.4V battery

ORP TESTR 10 WATERPROOF

Pocket-Size ORP Meter



- ORP (-999_+1000 mV/ 1mV & ±2 mV) hand-held meter.
- User-replaceable sensor
- Water and dustproof floatable IP67 body
- Hold function that freezes the instantaneous reading value.
- Wide platinum strip sensor for fast response and high performance.
- Sensor protective cover that can be used as a reservoir for calibration liquid and sample liquid

Stock Code	Model	Package Sizes/cm W-L-H	Packed Weight/Kg
421020060000000	ORP TESTR 10 WATERPROOF	6,5 x 21 x 4,5	0,200

Technical Specifications

Orp Measurement Range	-999 to +1000 mV
Precision	1mV
Accuracy	± 2 mV
Number of Calibration Points	1 (± 150 mV offset)
Special Functions/HOLD	Self-diagnosis; measurement Hold function;
Power Requirement	4 x 1.5V alkaline button batteries
Automatic shutdown	Auto-Off after 8.5 minutes

ECOTestr SALT

Pocket-Size Salinity Meter



- Hand-held salinity (0-10.00 ppt/ ±2% full scale) measuring device.
- Replace the battery without using any hand tool thanks to the battery clip slot
- Hold function that freezes the read value instantly for easy recording.
- Sensor protective cover that can be used as a reservoir for calibration liquid or samples
- Water and dustproof floatable IP67 body

Stock Code	Model	Package Sizes/cm W-L-H	Packed Weight/Kg
421020080000000	SALTTESTR WATERPROOF	13,5 x 24,5 x 3	1,475

Technical Specifications

Range	Up to 0-10.00 ppt
Precision	0.1 ppt
Accuracy	±% 1
Calibration Points	1 (digital, button)
ATC -Automatic temperature compensation	Yes
Holding the Measurement Value on Screen	Yes
Automatic shutdown	8.5 Minutes After Last Key Pressed
Power	4 X 1.5V "A76" Micro Alkaline Batteries
Body	IP67 Waterproof Case

ECO ECTESTR HIGH

Pocket-Size Conductivity Meter



- EC (0_19.90 mS/cm / 0.10 mS/cm & ±1% Full Scale) measuring device.
- Water and dustproof floatable IP-67 body.
- Automatic heat compensation (ATC).
- Manual calibration option for more precise reading.
- Automatic shutdown, warning messages.
- Hold function that freezes the read value instantly for easy recording.
- Replace the battery without using any hand tool thanks to the battery clip slot
- Sensor protective cover that can be used as a reservoir for calibration liquid or samples

Stock Code	Model	Package Sizes/cm W-L-H	Packed Weight/Kg
421020040000000	ECO TESTR EC HIGH WATERPROOF	13,5 x 24,5 x 3	0,145

Technical Specifications

Range	Up to 19.90 mS / cm
Precision	0.1 mS / cm
Accuracy	± 1% full scale (± 2% over 10 mS / cm)
Calibration Points	1 (Digital, Button)
ATC-Automatic Temperature Compensation	Yes
Non-Volatile Memory	Yes
Ability to Hold the Measurement Value on Screen (hold)	Yes
Automatic shutdown	8.5 Minutes After Last Key Pressed
Body	Lcd Display / IP 67 Waterproof Case
Power Requirement	4 X 1.5V "A76" Micro Alkaline Batteries



ECO ECTESTR LOW

Pocket-Size Low Conductivity Meter

- EC 0-1990 pS /cm Has: 10 pS /cm & ± 1% Full Scale) measuring device.
- Water and dustproof floatable IP-67 body.
- Automatic heat compensation (ATC).
- Manual calibration option for more precise reading.
- Automatic shutdown, warning messages.
- Hold function that freezes the read value instantly for easy recording.
- Replace the battery without using any hand tool thanks to the battery clip slot
- Sensor protective cover that can be used as a reservoir for calibration liquid or samples

Stock Code	Model	Package Sizes/cm W-L-H	Packed Weight/Kg
42102002000000	EC TESTR LOW WATERPROOF	13,5 x 24,5 x 3	0,145

Technical Specifications

Conductivity Measurement Range	.. up to 1990 uS / cm
Precision	0.1 mS / cm
Accuracy	± 1% full scale (± 2% over 10 mS / cm)
Calibration Points	1 (digital, button)
ATC - Automatic Temperature Compensation	Yes
Non-Volatile Memory	Yes
Ability to Hold the Measurement Value on Screen (hold)	Yes
Automatic shutdown	8.5 Minutes After Last Key Pressed
Body	LCD display / IP 67 Waterproof case
Power Requirement	4 X 1.5 V "A76" Micro alkaline batteries

Eutech Expert CTS Pocket Tester

Pocket-type Conductivity / TDS / Salinity / Temperature Meter



- Expert CTS Pocket Tester — designed for Conductivity, TDS, Salinity, and Temperature measurements
- Large 4-digit dual-line display
- Battery life, ready-to-read, and calibration indicators
- Automatic temperature compensation
- Automatic buffer recognition and calibration
- Multi-language operational instructions
- IP67 protection rating

Stock Code	Model	Package Sizes/cm W-L-H	Packed Weight/Kg
421029080000000	CTS TESTR EXPERT	13,5 x 24,5 x 3	0,94

Technical Specifications

Measurement Modes	Conductivity, TDS, Salinity, Temperature
Calibration Modes	Conductivity, TDS, Salinity, Temperature
Measurement Ranges	Conductivity: 0.00 to 20.00 mS TDS: 0.00 to 20.00 ppt (with TDS factor 1.00) Salinity: 0.0 to 10.00 ppt Temperature: 0°C to 50.0°C
Conductivity Resolution	10.00 µS/cm for 0 to 1990 µS/cm; 0.10 µS/cm for 2.00 to 20.00 mS/cm
TDS Resolution	10 ppm for 0 to 1990 ppm; 0.10 ppt for 2.00 to 20.00 ppt
Salinity Resolution	0.1 ppt
Temperature Resolution	0,1°C, 0,1°F
IP Protection Rating	IP 67
Battery Type	4×1.5V micro alkaline

EC TESTR MULTIRANGE 11+

Conductivity Meter with Multi-Parameter Interchangeable Sensor



- EC (0_200.0 ppm / 0.1 pmm ± 1% - 0_2000.0Pmm/ 10 Pmm & ± 1%, 0_10.00 ppt / 0.10 ppt & ± 1%) measuring device.
- Temperature measurement (0.0_50 °C/0.1 °C & ± 0.5 °C% or 32.0_ 122.0 °F/ 0,1 °F&± 0,9 °F
- ATC, temperature display, automatic shutdown, hold function.
- Waterproof and dustproof.
- User-replaceable SS316 stainless steel sensor.
- Adjustable TDS factor from 0.4_1.0 for more precise measurement.

Stock Code	Model	Package Sizes/cm W-L-H	Packed Weight/Kg
421020030000000	EC TESTR MULTI RANGE 11+	6,5 x 21 x 4,5	0,210

Technical Specifications

Selectable Measuring Ranges	.. Up to 2000 µS / cm/ .. Up to 20.00 mS / cm
Selectable Conductivity Measurement Availability	10 µS / cm ; 0.10 mS / cm
Accuracy	± 1% full scale
ATC / Temperature Indicator	Yes (0 to 50 ° C / 32 to 122 °F) / Yes
Calibration Points	2 automatic or 2 manual
Range	0 - 50.0 ° C or 32.0 - 122.0 °F
Temperature Sensitivity	0.1 °C / 0.1 ° F
Accuracy	± 0,5 ° C / ± 0,9 °F + 1 LSD
Auto Power-Off / Non-Volatile Memory	8.5 minutes after the last key was pressed/ Yes
Power Requirement	4 x 1.5 V 'A76' micro alkaline batteries (included)

PC TESTR 35

Pocket-Size pH and Conductivity Meter with Interchangeable Sensor



- pH, conductivity, and temperature measuring device
- PCTestr 35 full scale pH and 20.0 mS in two measuring ranges
- Performs up to 2 conductivity measurements
- 5-point pH and 2-point conductivity/TDS calibration
- Adjustable TDS factor (0.40-1.00) and temperature coefficient feature
- (0.0 - 10.0% per °C)

Stock Code	Model	Package Sizes/cm W-L-H	Packed Weight/Kg
421021030000000	PC TESTR 35 EUTECH	6,5 x 21 x 4,5	0,200

Technical Specifications

Ph Measurement Range	pH 0.00 to 14.00
Ph Measurement Accuracy	0.01 pH
Accuracy	± 0.01 pH
Conductivity Measurement Range	.. with 1999 μ S / cm ; 2,00 - 20,00 mS / cm
Conductivity Measurement Range	1 μ S / cm ; 0.01 mS / cm
Accurate	± 1% Full Scale
Normalization Temperature	25.0°C
Temperature Range	0,0 - 50,0 ° C / 32,0 - 120,0 °F
Automatic shutdown	8.5 minutes after the last key is pressed (can be disabled)
LCD Display / Power	Dual-screen LCD (2.1 x 2.7 cm) / 4 X 1.5 V "A76" Micro alkaline battery

PCS TESTR 35

Pocket Type pH, Conductivity, TDS, Salinity Meter with Interchangeable Sensor

- pH, conductivity, Total Dissolved Solids, Salinity, temperature measuring device.
- Low, medium, and high conductivity / TDS ranges- can even measure distilled water!
- Multi-Range 10.00 ppt or salinity measurement up to 1.00%
- 5-point pH, 3-point conductivity, TDS, and salinity calibration.
- Adjustable TDS factor (0.40 - 1.00) and temperature coefficient feature
- (0.0 - 10.0% per °C)



Stock Code	Model	Package Sizes/cm W-L-H	Packed Weight/Kg
421021070000000	PCS TESTR 35 EUTECH	6,5 x 21 x 4,5	0,200

Technical Specifications

pH Range /pH precision	0.00 to 14.00 pH / 0.01 pH
Conductivity Range	.. to 199.9 $\mu\text{S} / \text{cm}$; 200 to 1999 $\mu\text{S} / \text{cm}$; 2.00 to 20.00 mS / cm 0.1 $\mu\text{S} / \text{cm}$; 1 pS / cm ; 0.01 mS / cm
Conductivity precision	3 Auto / 3 Manual
Conductivity Calibration Points	0.0 - 99.9 ppm/ 100 - 999 ppm /
TDS Range	1.00 - 10.00 ppt
Salinity Range	0.0 - 99.9 ppm/ 100 - 999 ppm / 1.00 - 10.00 ppt/0.0 - 1.00%
Temperature range	0.0 - 50.0 °C / 32.0 - 120.0 °F
Non-Volatile Memory/HOLD	Yes
Automatic shutdown	8.5 minutes after the last key is pressed (can be disabled)
Power requirement	4 X 1.5 V "A76" Micro alkaline batteries

CYBERSCAN PC 450

Bag pH, Conductivity, TSD, Temperature Meter



- pH, conductivity, TDS, and temperature measuring device
- Dust and waterproof floatable IP-67 body
- Automatic fluid recognition for pH
- Automatic measuring range in conductivity measurement
- Large easy-to-read LCD display
- Retrospective recording of measured parameters

Stock Code	Model	Package Sizes/cm W-L-H	Packed Weight/Kg
421021130000000	PC 450 METER KIT EUTECH	34 x 41.5 x 10.5	2,206

Technical Specifications

Ph Range /Ph Sensitivity	-2.00 Ph to 16.00 Ph / 0.01 Ph
Mv Range / mv sensitivity	± 2000 mV / 0.1 mV ± 999.9 mV; beyond 1 mV
Conductivity Range	0 to 200 mS; if using COMBIO3BW probe 0 to 20 mS
conductivity precision	0.01 µS - 0.1 mS
TDS Range / TDS precision	0 to 200 ppt (TDS factor 1.0) / 0.01 ppm to 0.1 ppt
Temperature Range	-10.0 - 110.0°C (14.0 - 230.0°F)
View	Special LCD with backlighting
Memory / Output	Stores up to 500 data/ USB or RS232
Real Time Clock	Time and date stamp on calibration and stored data
Temperature Compensation	-10 to 110°C automatic or manual

POOL LAB 1.0

Photometric Pool Water Analyzer



- Measuring up to 12 parameters
- Connectivity with Bluetooth-compatible smart devices
- Ease of use with 6 keys
- IP68 waterproof elegant body
- Fixed and interchangeable bathtub feature
- Powerful application and software
- Free cloud space
- Ability to report measurement values
- -Starter pack content

- pH-20 Tablet
- DPD3 -20 Tablet
- Cyanuric Acid-10 Tablet
- DPD1-20 Tablet
- Alkalinity -10 Tablet

Free Chlorine (DPD)/0.00-6.00 ppm
Total Chlorine (DPD)/0.00-6.00 ppm
pH / 6.50 - 8.40

Alkalinity / 0.00 - 300 ppm
Cyanuric Acid / 0.00 - 160 ppm
Active Oxygen / 0.00 - 30 ppm*

Chlorine Dioxide / 0.00 - 11.40 ppm* *
Ozone / 0.00 - 4.00 ppm* *
Hydrogen Peroxide (LR)/0.00-2.90 ppm*

Hydrogen Peroxide (HR)/0.00-200 ppm*
Total Hardness / 0.00 - 500 ppm*
Calcium Hardness / 0.00 - 500 ppm*
Bromine / 0.00 - 13.50 ppm* *

Stock Code	Model	Package Sizes/cm W-L-H	Packed Weight/Kg
421023100000000	WID POOL LAB 1.0	14 x 28 x 7	0,600

** *Tablets are not included in the standard box content.
"If chlorine is present in the sample water, "Glycine "requires a reactive tablet.
"Glycine" reactive tablets are not included in the standard box content.

Stock Code	Stock Name	Description	Included in Package
421061000000600	WID PHENOL RED TABLET 50PCS	Ph Tablet 50 Pcs	✗
421061000000300	WID DPD1 50 TABLETS	Free Chlorine Tablet 50 Pcs	✗
421061000000400	WID DPD3 50 TABLETS	Total Chlorine Tablet 50 Pcs	✗
421061000000800	WID ALKALINITY 50 TABLETS	Alkalinity Tablet 50 Pcs	✗
421053200500100	WID CYA 50 TABLETS	Cyanuric Acid (Stabilizer) Tablet 50 Pcs	✗
421061000001300	WID DPD4 50 TABLETS	Active Oxygen Tablet 50 Pcs	✗
421061000001200	WID GLYCINE 50 TABLETS	Glycine Tablet 50Pcs (Additional Tablet For Chlorine Dioxide, Bromine And Ozone Measurement)	✗
421061000001400	WID HYD. PEROXIDE LR 50 TABLETS	Hydrogen Peroxide Low Range Tablet 50 Pcs	✗
421061000001900	WID HYD. PEROXIDE HR 50 TABLETS	Hydrogen Peroxide High Range Tablet 50 Pcs	✗
421061000002000	WID ACIDIFYING PT 50 TABLETS	Acidifying Tablets 50 Pcs (Additional Tablet For Hydrogen Peroxide High Range Measurement)	✗
421061000001600	WID TOTAL HARDNESS 10TH2	Total Hardness 10Th2 20 ML Liquid (50 Tests)	✗
421061000001500	WID TOTAL HARDNESS 20TH1	Total Hardness 20Th1 20 ML Liquid (50 Tests)	✗
421061000001700	WID CALCIUM HARDNESS 20CAH1	20Cah1 20 ML Liquid (50 Tests)	✗
421061000001800	WID CALCIUM HARDNESS 20CAH2	20Cah2 20 ML Liquid (50 Tests)	✗

POOL LAB 2.0

Photometric Pool Water Analyzer



- Measurement up to 24 parameters
- Connection to the Bluetooth-compatible smart devices
- Easy use with 9 buttons
- IP68 waterproof elegant body
- 3 fixed and replaceable tubs
- Powerful application and software

Free cloud storage

Reporting measurement values

Content of startup pack;

-20 Tablet Phenol Red - 10 Tablet Alkalinity-M

-20 Tablet DPD N° 1 - 10 Tablet CYA-Test

-10 Tablet DPD N° 3

Stock Code

Model

Package Sizes/cm
W-L-H

Packed
Weight/Kg

421023102000000	WID POOL LAB 2.0	9,5 x 12 x 29,5	0.78
-----------------	------------------	-----------------	------

* * *Tablets are not included in the standard box content.

"If chlorine is present in the sample water, "Glycine "requires a reactive tablet.

"Glycine" reactive tablets are not included in the standard box content.

Parameter

Parameter	Measurement Ranges	Parameter	Measurement Ranges
Active Oxygen (MPS)	0.00 - 20.0 mg/l (ppm)*	Calcium hardness	0 - 500 mg/l (ppm)*
Alkalinity (acid cov.)	0 - 200 mg/l (ppm)	Copper	0.00 - 5.00 mg/l (ppm)*
Aluminum	0.00 - 0.30 mg/l (ppm)*	Nitrate	1 - 50 mg/l (ppm)*
Ammonia	0.00 - 1.20 mg/l (ppm)*	Nitrite (LR)	0.00 - 1.50 mg/l (ppm)*
Boron	0.00 - 13.0 mg/l (ppm)**	Ozone	0.00 - 4.00 mg/l (ppm)**
Chloride (fCl / cCl / tCl)	0.00 - 6.00 mg/l (ppm)	PH	6.50 - 8.40 pH
Chloride (HR)	5 - 200 mg/l (ppm)*	PHMB	5 - 60 mg/l (ppm)*
Chloramine	0.00 - 6.00 mg/l (ppm)*	Phosphate(LR)	0.00 - 4.00 mg/l (ppm)*
Chlorine dioxide	0.00 - 11.0 mg/l (ppm)**	Phosphate (HR)	0 - 80 mg/l (ppm)*
Cyanuric acid (Stabil.)	0 - 100 mg/l (ppm)	Sulfate	5 - 100 mg/l (ppm)*
Iron (LR)	0.00 - 1.00 mg/l (ppm)*	Hydrogen peroxide (LR)	0.00 - 2.40 mg/l (ppm)*
Total hardness	0 - 500 mg/l (ppm)*	Hydrogen peroxide (HR)	0 - 180 mg/l (ppm)*
Urea	0.10 - 2.50 mg/l (ppm)*	Zinc	0.00 - 1.00 mg/l (ppm)*
Potassium	0.70 - 12.0 mg/l (ppm)**		

CONTENT OF THE KIT

Basic Kit



















1 x Bluetooth and WIFI featured PoolLab 2.0
IP68 waterproof
1 x 3 fold tub (replaceable)
1 x light protection cover
3 x plastic mixing rod
1 x 10 ml syringe

Basic Kit Reagents

20 Tablet Phenol Red
20 Tablet DPD N° 1
10 Tablet DPD N° 3
10 Tablet Alkalinity-M
10 Tablet CYA-Test

LabCom Uygulaması / Yazılımı

Providing and monitoring free data record of the measured parameters on LabCom software

	Stock Code	Stock Name	Description	Included in Package
	42106100000600	WID PHENOL RED TABLET 50PCS	Ph Tablet 50 Pcs	✗
	42106100000300	WID DPD1 50 TABLETS	Free Chlorine Tablet 50 Pcs	✗
	42106100000400	WID DPD3 50 TABLETS	Total Chlorine Tablet 50 Pcs	✗
	42106100000800	WID ALKALINITY 50 TABLETS	Alkalinity Tablet 50 Pcs	✗
	421053200500100	WID CYA 50 TABLETS	Cyanuric Acid (Stabilizer) Tablet 50 Pcs	✗
	421061000001300	WID DPD4 50 TABLETS	Active Oxygen Tablet 50 Pcs	✗
	421061000001200	WID GLYCINE 50 TABLETS	Glycine Tablet 50Pcs (Additional Tablet For Chlorine Dioxide, Bromine And Ozone Measurement)	✗
	421061000001400	WID HYD. PEROXIDE LR 50 TABLETS	Hydrogen Peroxide Low Range Tablet 50 Pcs	✗
	421061000001900	WID HYD. PEROXIDE HR 50 TABLETS	Hydrogen Peroxide High Range Tablet 50 Pcs	✗
	421061000002000	WID ACIDIFYING PT 50 TABLETS	Acidifying Tablets 50 Pcs (Additional Tablet For Hydrogen Peroxide High Range Measurement)	✗
	421061000001600	WID TOTAL HARDNESS 10TH2	Total Hardness 10Th2 20 ML Liquid (50 Tests)	✗
	421061000001500	WID TOTAL HARDNESS 20TH1	Total Hardness 20Th1 20 ML Liquid (50 Tests)	✗
	421061000001700	WID CALCIUM HARDNESS 20CAH1	20Cah1 20 ML Liquid (50 Tests)	✗
	421061000001800	WID CALCIUM HARDNESS 20CAH2	20Cah2 20 ML Liquid (50 Tests)	✗
	421061000002700	WID DPD2 50 TABLETS	Additional Auxiliary Tablet for Chloramine Measurement, 50 Pcs	✗
	421061000002800	WID COPPER NO 1 50 TABLETS	I Free Copper Tablet, 50 Pcs	✗
	421061000002900	WID COPPER NO 2 50 TABLETS	I Total Copper Tablet, 50 Pcs	✗
	421061000003000	WID IRON LR 50 TABLETS	I Low Range Iron Tablet, 50 Pcs	✗
	421061000003100	WID NITRATE NO 1 POWDER 50 TABLETS	I Nitrate Measurement Powder Reagent, 50 Pcs	✗
	421061000003200	WID NITRATE NO 2 POWDER 50 TABLETS	I Nitrate Measurement Additional Powder Reagent, 50 Pcs	✗
	421061000003300	WID NITRITE LR POWDER 50 TABLETS	I Nitrite Measurement Powder Reagent, 50 Pcs	✗
	421061000003400	WID PHOSPHATE LR NO 1 POWDER 50LI	I Phosphate NO 1 Measurement Powder Reagent, 50 Pcs	✗
	421061000003500	WID PHOSPHATE LR NO 2 50 TABLETS	I Phosphate NO 2 Measurement Additional Tablet, 50 Pcs	✗
	421061000003600	WID SULPHATE POWDER 50 TABLETS	I Sulfate Measurement Powder Reagent, 50 Pcs	✗

SUTEST POOL WATER TEST KIT TABLET

pH Chlorine Test Kit

- measuring kit with pH and Chlorine tablet
- Measuring Range: Chlorine 0.1 - 3.0 ppm, pH 6.8 - 8.2
- 20 Pcs pH Tablets - 20 Pcs Free Chlorine Tablets



Stock Code

Model

Description

421040101020020	SUTEST POOL WATER TEST KIT TABLET AS SERIES	Chlorine 0,1 - 3,0 Ppm, Ph 6,8 - 8,2
-----------------	---	--------------------------------------

SUTEST MEASURING REAGENTS

Reagents

- pH and Chlorine titrimetric measurement kits
- Measuring Range: Chlorine 0.5 - 10.0 ppm, pH 6.8 - 8.2



Stock Code

Model

Description

421050110000400	SUTEST DPD1 RAPID 1000 TABLETS	Ph Tablet 1.000 Pcs
421051110000300	SUTEST DPD1 RAPID 1000 TABLETS	Free Chlorine Tablet 1.000 Pcs

WATER ID MEASUREMENT REAGENTS

pH Chlorine Test Kit

- pH and Chlorine photometric and titrimetric measurement kits
- Measurement Range: Chlorine 0,5 - 10,0 ppm, pH 6,8 - 8,2



Stock Code	Model	Description
421061000002400	WID PHENOL RED RAPID TABLET 500 TABLETS	Rapid pH Table, 500 Pcs
421061000002200	WID PHENOL RED TABLET 500 TABLETS	Photometer Ph Tablet, 500 Pcs
421061000002300	WID DPD1 RAPID TABLET 500TABLETS	Rapid Free Chlorine Tablet, 500 Pcs
421061000002100	WID DPD1 TABLET 500 TABLETS	Photometer Free Chlorine Tablet, 500 Pcs

LAMOTTE MEASURING REAGENTS

Reagents

- pH and Chlorine titrimetric measurement kits
- Measuring Range: Chlorine 0.5 - 10.0 ppm, pH 6.8 - 8.2



Stock Code	Model	Description
421050110000400	LAMOTTE PHENOL RED TABLETS 1.000PCS PH TEST KIT	Ph Tablet 1.000 Pcs
421051110000300	LAMOTTE DPD1 1.000 TABLETS TEST KIT LAMOTTE	Free Chlorine Tablet 1.000 Pcs
421052110000500	LAMOTTE DPD3 1.000 TABLETS TEST KIT	Total Chlorine Tablet 1.000 Pcs

WATER TEST POOL WATER TEST KIT LIQUID

pH Chlorine Test Kit

- pH and Chlorine titrimetric measurement kits
- Measuring Range: Chlorine 0.1 - 3.0 ppm, pH 6.8 - 8.2



Stock Code	Model	Description	Packed Weight/Kg
421040001020000	SUTEST POOL WATER TEST KIT LIQUID	Titrimetric Ph & Chlorine Measurement Kit	0,170
421040101020000	SUTEST POOL WATER TEST KIT TABLET DROP	Ph Chlorine Testkit With Tablet	0,105

WATER TEST ANALYSIS SETS

Analysis Sets

- Titrimetric analysis sets



Stock Code	Model	Description	Packed Weight/Kg
421040019000010	SUTEST DIALYSIS WATER ANALYSIS SET	Chlorine : 0,1 - 3,0 Ppm Ph: 6-8 - 8,2 Hardness : 1 Drop = 1 Fr °	0,170
421040015000010	SUTEST DRINKING WATER ANALYSIS SET	Chlorine : 0,1 - 3,0 Ppm Ph: 6-8 - 8,2 Hardness : 1 Drop = 1 Fr °	0,105

OTHER TEST KITS

Water Test Other Test Kits

- Free Chlorine and Total Hardness titrimetric measurement kits
 - Iron and chlorine dioxide measurement kits
- Sensitivity: Free Chlorine 0.1 - 3.0 ppm
Sensitivity: Total Hardness 1 drop = 1 F° / 1 ml 100 ppm
75 possibility of conducting tests





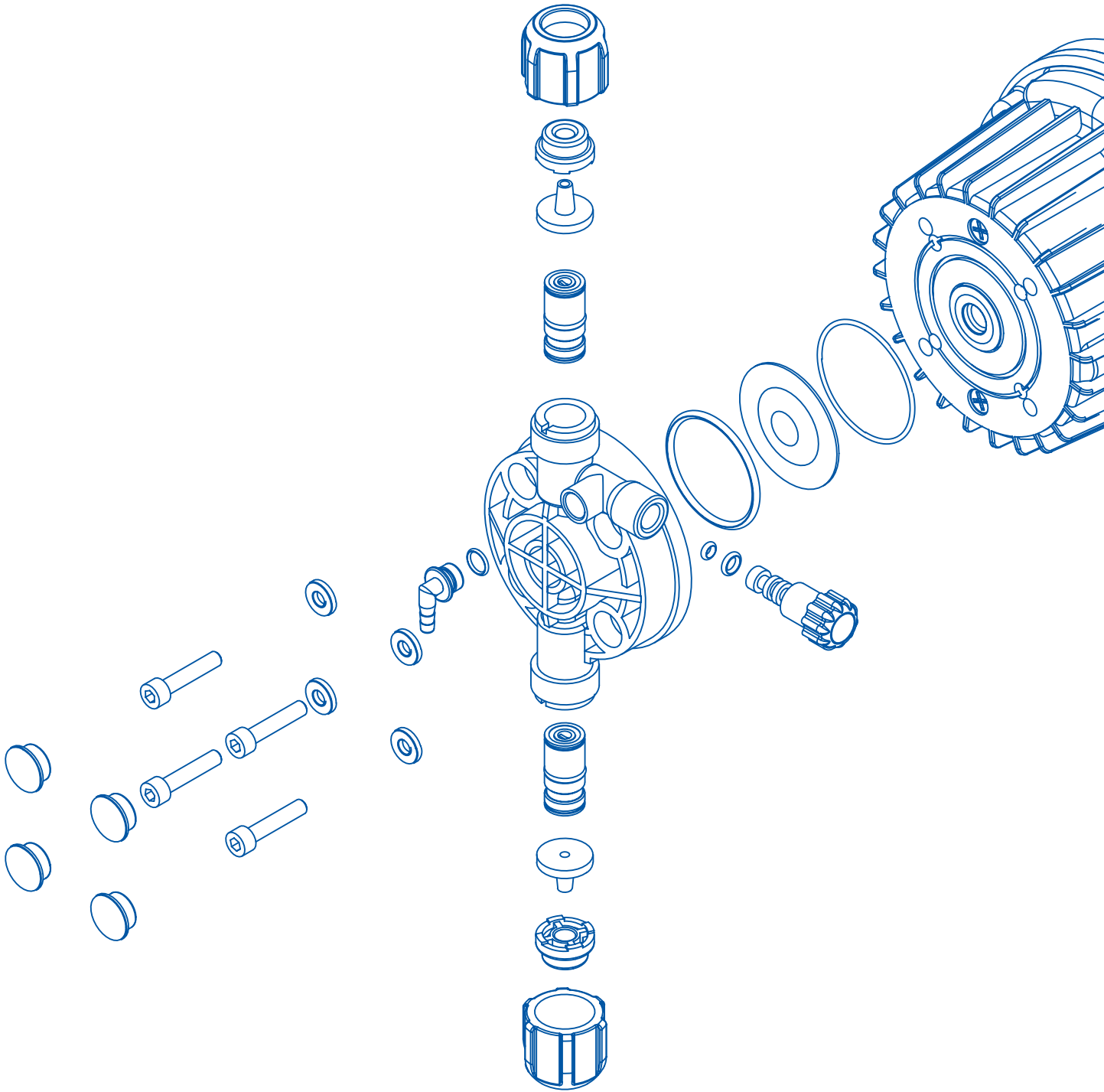

Stock Code	Model	Description
421040002000000	SUTEST FREE CHLORINE TEST KIT O.TOLIDON DROP SERIES	0,1 Ppm - 3,0 Ppm
421040102000000	SUTEST FREE CHLORINE TEST KIT TABLET DROP SERIES	0,1 Ppm - 3,0 Ppm
421040005000000	SUTEST TOTAL HARDNESS TEST KIT DROP SERIES	1 Drop - 1 Freech* 1 Drop- 1 German
421040004000000	SUTEST TOTAL IRON TEST KIT DROP SERIES	0,5 Ppm - 10 Ppm
421040007000000	SUTEST CHLORINE DIOXIDE TEST KIT DROP SERIES	0,1 Ppm - 3,0 Ppm
421040021000010	SUTEST SILICATE TEST KIT DROP SERIES	0,5 Ppm - 8,0 Ppm
421040018000010	SUTEST CYANURIC ACID TEST KIT DROP SERIES	30 Ppm - 100 Ppm
421040020000010	SUTEST SULFATE TEST KIT DROP SERIES	50 Ppm - 200 Ppm
421040014000000	SUTEST ALKALINITY TEST KIT DROP SERIES	1 Drop - 50 Ppm
421040017000010	SUTEST AMMONIUM TEST KIT DROP SERIES	0,5 Ppm - 10 Ppm
421040008000100	SUTEST CHLORINE PH TEST KIT LIQUID DROP SERIES	Klor : 0,1 - 3,0 Ppm Ph : 6,8 - 8,2
421040006000000	SUTEST NITRATE TEST KIT DROP SERIES	1 Ppm - 10 Ppm
421049022000020	SUTEST NITRATE TEST KIT HR DROP SERIES	1 Drop = 25 Ppm
421049022000010	SUTEST NITRATE TEST KIT LR DROP SERIES	0,1 Ppm - 3 Ppm
421040001000020	SUTEST PH TEST KIT LIQUID DROP SERIES	6,8 Ph - 8,2 Ph
421040011000010	SUTEST CHLORIDE TEST KIT DROP SERIES	1 Drop = 30 Ppm
421040023000010	SUTEST COPPER KIT DROP SERIES	0,05 Ppm - 1 Ppm
421049023000010	SUTEST PHOSPHATE TEST KIT LR DROP SERIES	0,5 Ppm - 30 Ppm







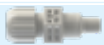









12 Spare Parts

12 Spare Parts

Spare Parts

	Stock Code	Stock Name	Description
	600110200131000	YP KAFA TAKIMI 40V ECO	Spare Part
	600110200431000	YP KAFA TAKIMI 40E ECO	Spare Part
	600501010400000	YP PUMP HEAD SET 40V	Spare Part
	600501020400000	YP PUMP HEAD SET 40E	Spare Part
	600501030400000	YP HEAD SET 40 VPTFE	Spare Part
	600501010500000	YP PUMP HEAD SET 50V	Spare Part
	600501020500000	YP PUMP HEAD SET 50E	Spare Part
	600501030500000	YP HEAD SET 50 VPTFE	Spare Part
	600501010700000	YP HEAD SET 70V	Spare Part
	600501020700000	YP HEAD SET 70E	Spare Part
	600501030700000	YP HEAD SET 70 VPTFE	Spare Part
	600502010010000	YP HEAD SET EMD P VPP5	Spare Part
	600502010020000	YP HEAD SET EMD P VPP316	Spare Part
	600502010030000	YP HEAD SET EMD P VPVCS	Spare Part
	600502010040000	YP HEAD SET EMD P VSS316	Spare Part
	600502010050000	YP HEAD SET EMD P VPFS	Spare Part
	600503010010000	YP HEAD SET EMD M 1 VPVCP	Spare Part
	600503010020000	YP HEAD SET EMD M 1 VPSS	Spare Part
	600503010030000	YP HEAD SET EMD M 1 VPVCCP	Spare Part
	600503010040000	YP HEAD SET EMD M 1 VSSS	Spare Part
	600503010050000	YP HEAD SET EMD M VPFS	Spare Part
	600110200126101	PUMP HEAD EMD M 2 VPVCPX	Spare Part
	600110200127101	PUMP HEAD EMD M 2 VPVCS	Spare Part
	600110200128101	PUMP HEAD EMD M 2 VPVDFPX	Spare Part
	600110200124101	PUMP HEAD EMD M 2 VSSS	Spare Part
	600110200126201	PUMP HEAD EMD M 3 VPVCPX	Spare Part
	600110200127201	PUMP HEAD EMD M 3 VPVCS	Spare Part
	600110200128201	PUMP HEAD EMD M 3 VPVDFPX	Spare Part
	600507010101000	YP INJECTION SET 4X6 V	Spare Part For Dosing Pump
	600507020101000	YP INJECTION SET 4X6 E	Spare Part For Dosing Pump
	600507030101000	YP INJECTION SET 4X6 P	Spare Part For Dosing Pump
	600507040101000	YP INJECTION SET 4X6 EP	Spare Part For Dosing Pump
	600110700212100	INJECTION SET METAL 4X6 E ASPENDOSE	Spare Part For Dosing Pump
	600110700211100	INJECTION SET METAL 4X6 V ASPENDOSE	Spare Part For Dosing Pump
	600110700323000	INJECTION SET 4X7 P	Spare Part For Dosing Pump
	600110700343000	INJECTION SET 9X12 P	Spare Part For Dosing Pump
	600110700341000	INJECTION SET 9X12 V	Spare Part For Dosing Pump
	600110700348000	INJECTION SET 9X12 VP-PTFE	Spare Part For Dosing Pump
	600110700144000	INJECTION SET EMD 20MM PP	Spare Part For Dosing Pump
	600110700145000	INJECTION SET EMD 20MM PVC	Spare Part For Dosing Pump
	600110700143000	INJECTION SET EMD 20MM PVDF	Spare Part For Dosing Pump

	Stock Code	Stock Name	Description
	60050801011000	YP SUCTION SET 4X6 V	Spare Part For Dosing Pump
	600508010121000	YP SUCTION SET 4X6 VS	Spare Part For Dosing Pump
	60050802011000	YP SUCTION SET 4X6 E	Spare Part For Dosing Pump
	600508020121000	YP SUCTION SET 4X6 ES	Spare Part For Dosing Pump
	60050803011000	YP SUCTION SET 4X6 P	Spare Part For Dosing Pump
	600508030121000	SUCTION SET 4X6 PS	Spare Part For Dosing Pump
	60050804011000	YP SUCTION SET 4X6 EP	Spare Part For Dosing Pump
	600508040121000	YP SUCTION SET 4X6 EPS	Spare Part For Dosing Pump
	600110800530000	SUCTION SET 9X12 P	Spare Part For Dosing Pump
	600110800531000	SUCTION SET 9X12 PS	Spare Part For Dosing Pump
	600110800510000	SUCTION SET 9X12 V	Spare Part For Dosing Pump
	600110800581000	SUCTION SET 9X12 VPS-PTFE	Spare Part For Dosing Pump
	600110800511000	SUCTION SET 9X12 VS	Spare Part For Dosing Pump
	600110800410000	SUCTION SET EMD 20MM PP	Spare Part For Dosing Pump
	600110800410100	SUCTION SET EMD 20MM PVC	Spare Part For Dosing Pump
	600110800410200	SUCTION SET EMD 20MM PVDF PVC	Spare Part For Dosing Pump
	600521010210100	YP ASPENDOSE INJECTION & SUCTION SET A	Spare Part For Dosing Pump
	600521010220100	YP ASPENDOSE INJECTION & SUCTION SET D	Spare Part For Dosing Pump
	600521010230100	YP ASPENDOSE INJECTION & SUCTION SET R	Spare Part For Dosing Pump
	600505020001000	YP ASPENDOSE TUBE SET A-D	Spare Part
	600505030002000	YP ASPENDOSE TUBE SET R	Spare Part
	600521010320110	YP ASPENDOSEHOSE R 2X4	Spare Part
	600511010120100	YP CHECK VALVE SET 4050 VITON	Spare Part For Dosing Pump
	600511020120100	YP CHECK VALVE SET 4050 EPDM	Spare Part For Dosing Pump
	600511030120102	CHECKVALVE SET 4050 V-PTFE	Spare Part For Dosing Pump
	600511010110100	YP CHECKVALVE SET 70 V 1	Spare Part For Dosing Pump
	600511020110100	YP CHECK VALVE SET 70 E	Spare Part For Dosing Pump
	600511030110100	YP CHECK VALVE SET 70 V-PTFE	Spare Part For Dosing Pump
	600112822010000	CHECK VALVE SET P VPCP LOWER	Checkvalve Set
	600112822011000	CHECKVALVE SET P VPCP UP	Checkvalve Set
	600112822000000	CHECK VALVE SET P VPSS LOWER	Checkvalve Set
	600112822001000	CHECLVALVE P VPSS UP	Checkvalve Set
	600112821010000	CHECK VALVE SET M VPCP LOWER	Checkvalve Set
	600112821011000	CHECK VALVE SET M VPCP UPPER	Checkvalve Set
	600112821000000	CHECK VALVE SET M VPSS LOWER	Checkvalve Set
	600112821001000	CHECK VALVE SET M VPSS UPPER	Checkvalve Set
	600112821010010	CHECK VALVE SET M VPPXP LOWER	Checkvalve Set
	600112821011010	CHECK VALVE SET M VPPXP UPPER	Checkvalve Set
	600112821040000	CHECK VALVE M VPVCCP LOWER	Checkvalve Set
	600112821041000	CHECK VALVE M VPVCCP UPPER	Checkvalve Set

	Stock Code	Stock Name	Description
	600112821030010	CHECK VALVE SET M VPVDFXP LOWER	Checkvalve Set
	600112821031010	CHECK VALVE SET M VPVDFXP UPPER	Checkvalve Set
	600112821020000	CHECK VALVE SET M VSS5 LOWER	Checkvalve Set
	600112821021000	CHECK VALVE SET M VSS5 UPPER	Checkvalve Set
	600112821050010	CHECK VALVE SET M 1 1/8 VPVCPX YL LOWER	Checkvalve Set
	600112821051010	CHECK VALVE SET M 1 1/8 VPVCPX YL UPPER	Checkvalve Set
	600112821050000	CHECK VALVE SET M 1 1/8 VPVCS5 YL LOWER	Checkvalve Set
	600112821051000	CHECK VALVE SET M 1 1/8 VPVCS5 YL UPPER	Checkvalve Set
	600112821050020	CHECKVALVE M 1 1/8" VPVDFPX YL BOTTOM	Checkvalve Set
	600112821051020	CHECKVALVE M 1 1/8" VPVDFPX YL UPPER	Checkvalve Set
	600112002100000	DIAPHRAGM 66MM EMD P	Diaphragm
	600112002200000	DIAPHRAGM 110MM EMD M	Diaphragm
	600112002300000	DIAPHRAGM 120MM EMD M	Diaphragm
	600112002400000	DIAPHRAGM 140MM EMD M	Diaphragm
	500010012100220	GLAND COVER 2 PVDF	Spare Part Gland Cover 2 PvdF
	500010006112000	HOSE TIGHTENER 4X6 PVDF	Hose Tightener
	500010005112000	HOSE END PIPE 4X6 PVDF	Hose End Pipe
	500010012100230	GLAND COVER 2 PVDF GREY	Spare Part Gland Cover 2 PvdF
	500010006113000	HOSE TIGHTENER 4X6 PVDF GREY	Hose Tightener
	500010005113000	HOSE END PIPE 4X6 PVDF GREY	Hose End Pipe
	500010012200320	GLAND COVER 3/4 16MM PVDF	Spare Part Gland Cover 3/4 16Mm PvdF
	500010005132000	HOSE END PIPE 9X12 PVDF	Hose End Pipe
	500010006132000	HOSE TIGHTENER 9X12 PVDF	Hose Tightener
	600110600200000	GLAND SET 4X6	Spare Part
	600110600300000	GLAND SET 6X8	Spare Part
	410190021100001	ELECTRODE FIXIN GLAND 1/2-12MM PP	ELECTRODE FIXING GLAND
	600522010100100	YP VALVE 1/2 - 1/2	Valve For Electrode Housings
	600522010200100	YP VALVE 1/2 - EASY CONNECT	Valve For Electrode Housings
	600113530000100	VALVE FITTING - FITTING	Valve For Electrode Housings
	500010029103100	DIRT HOLDER FILTER 1 ELECTRODE HOUSING	Spare Part For Electrode Housings
	500010029103105	DIRT HOLDER FILTER 2 ELECTRODE HOUSING	Spare Part For Electrode Housings
	600112410020000	FLOW CELL SINGLE ELEC. WITH FILTER	Flow Cell With Dual Inputs For 12 Mm Sensors.
	704104501000000	WASHABLE CARTIDGE FILTER 280 MICRON SS 316	Cartidge Filter

	Stock Code	Stock Name	Description
	704101100040060	HOSE PE 4X6	Hose
	70410110040060	HOSE PVC 4X6	Hose
	704101100040070	HOSE PE 4X7	Hose
	704101100060080	HOSE PE 6X8	Hose
	704101100090120	HOSE PE 9X12	Hose
	70410110090120	HOSE PVC 9X12	Hose

13 Technical Documents

A technical drawing or blueprint is shown with a blue color overlay. The drawing includes various geometric shapes, lines, and text annotations such as 'h-0.20', 'h-0.90', and 'h-0.90'. A calculator is visible in the bottom right corner, and a pen is lying across the drawing. The text 'Technical Documents' is centered over the drawing.

Technical Documents

ORP ELECTRODE OPERATION CHART

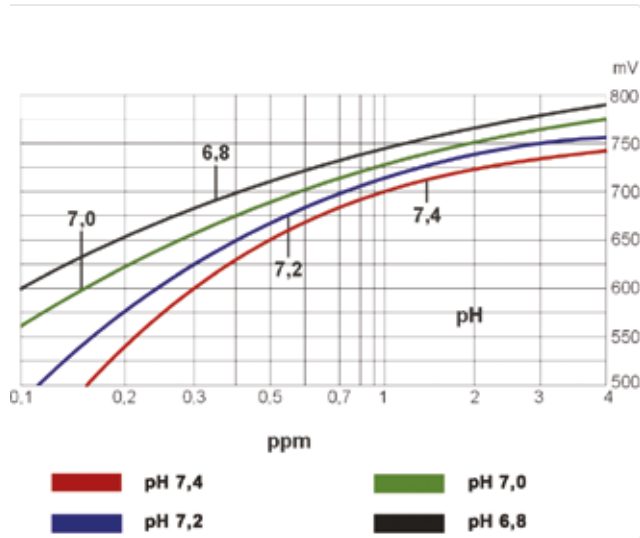

PROPORTIONAL CONTROL CHART

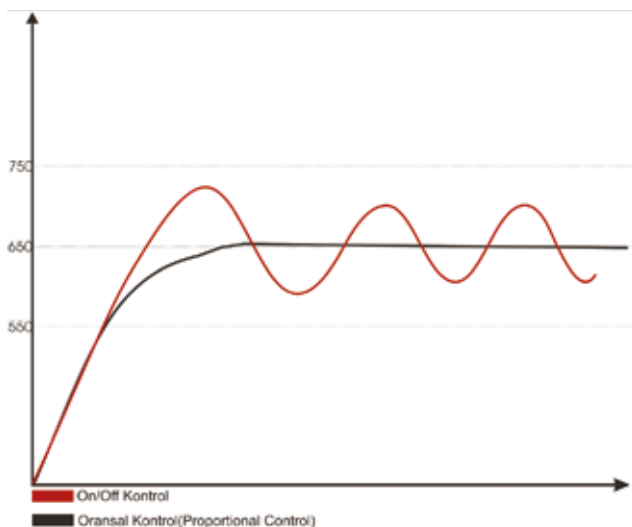

FLOW RATE PRESSURE CHARTS

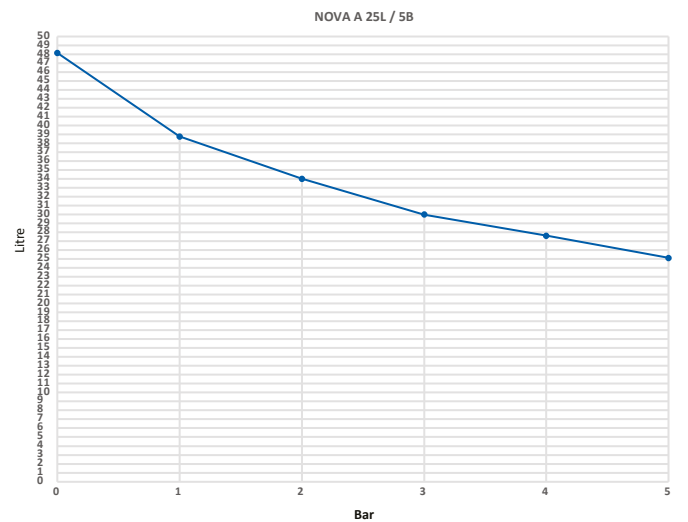
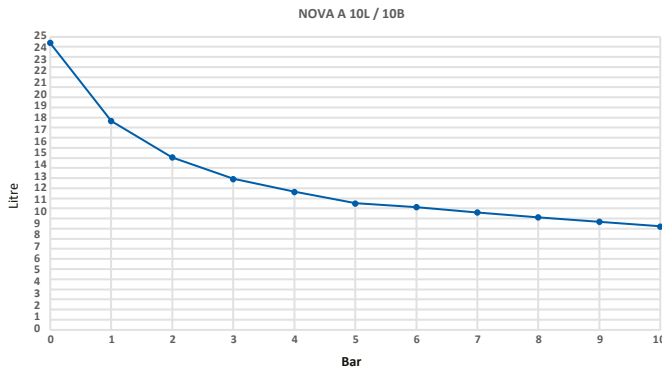
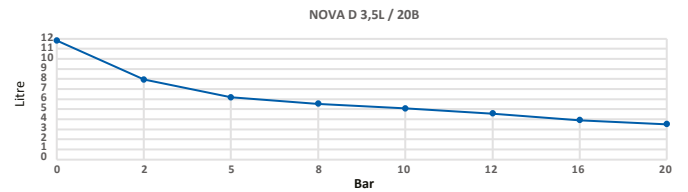
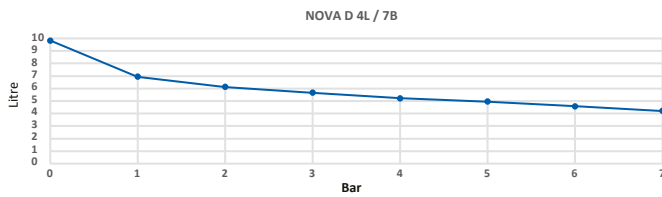
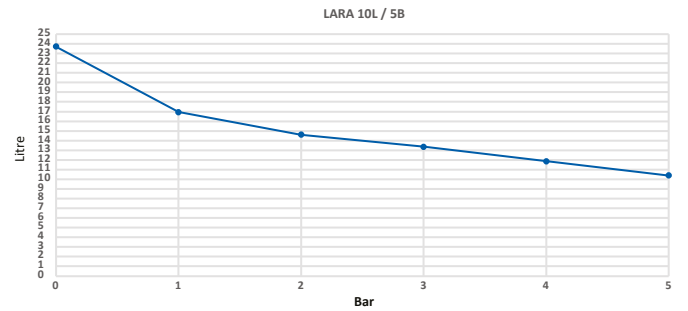
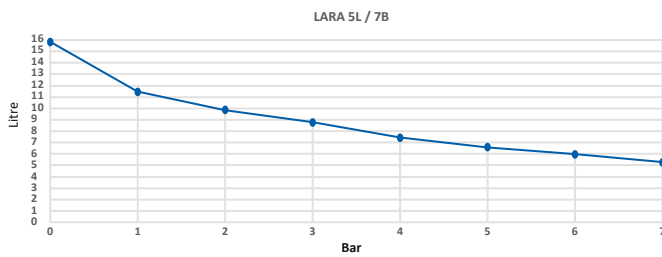
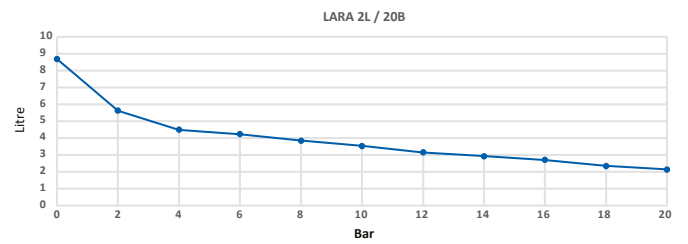
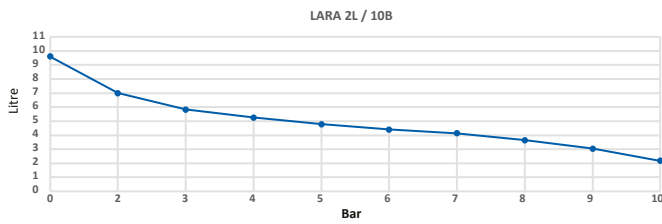
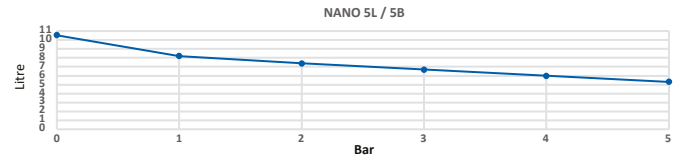
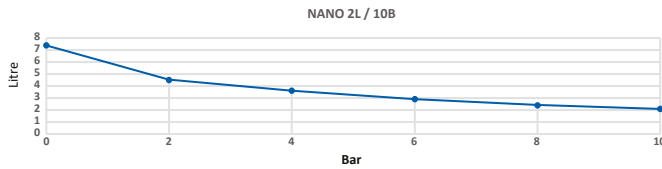
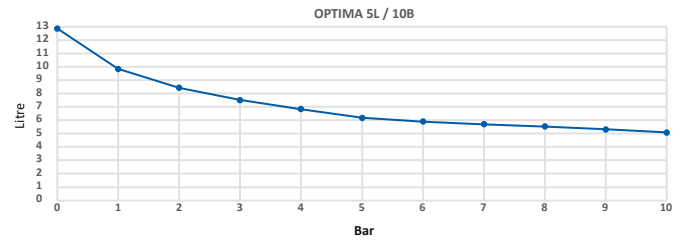
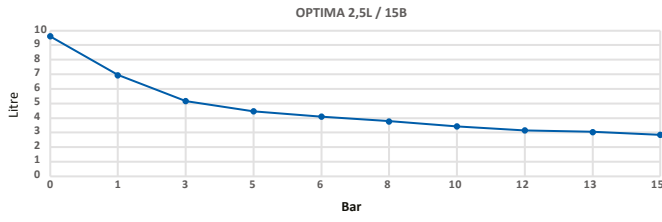

FLOW RATE PRESSURE CHARTS

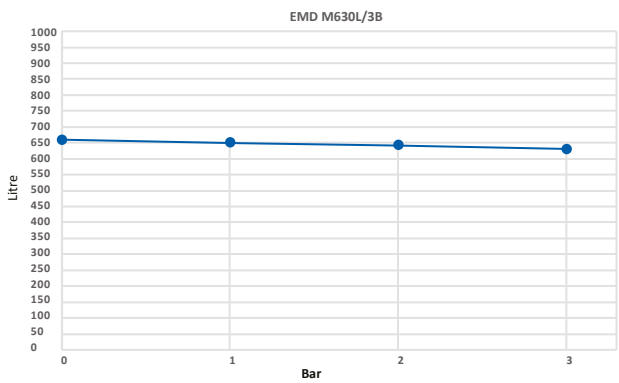
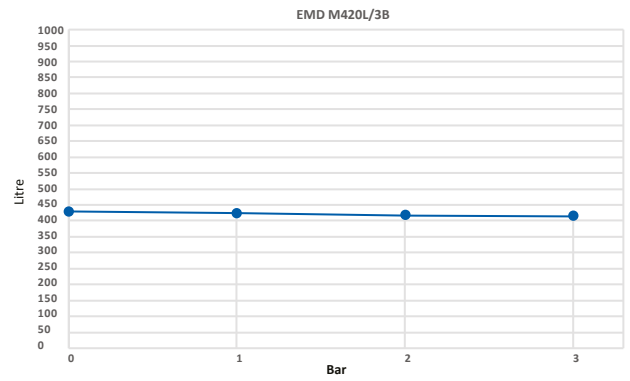
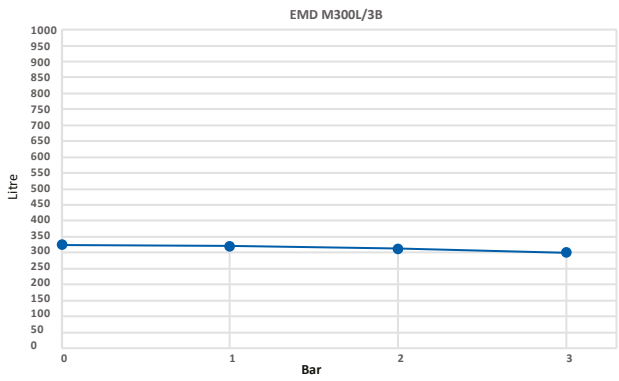
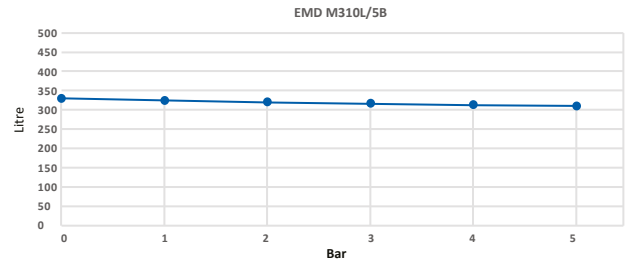
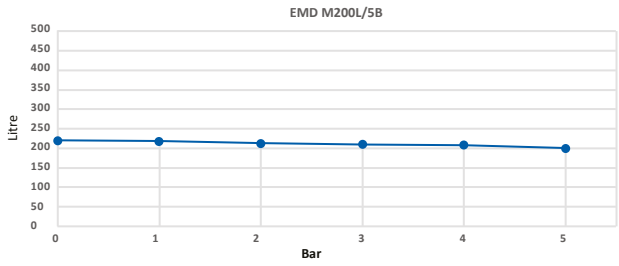
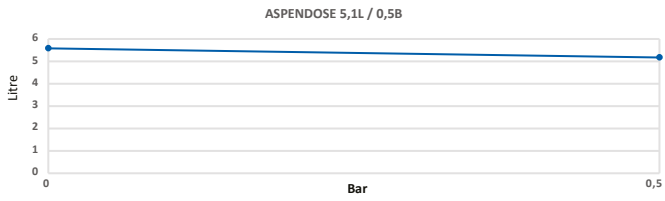
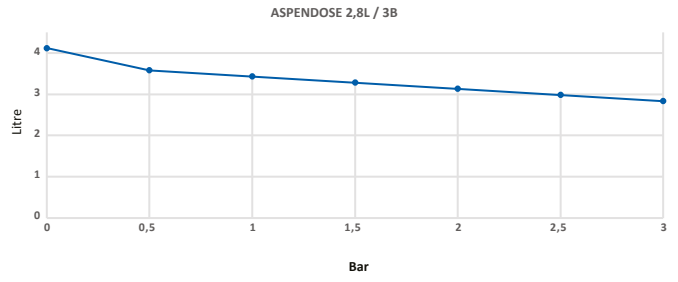
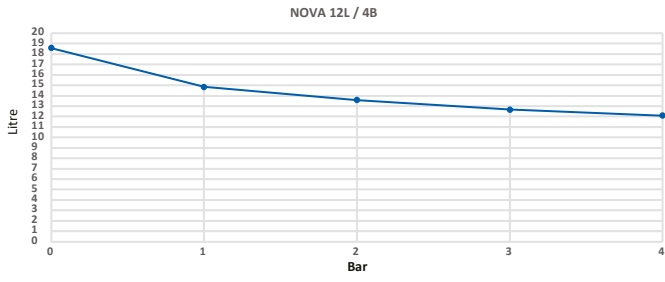

POOL CONTROL SYSTEM CONNECTION DIAGRAM

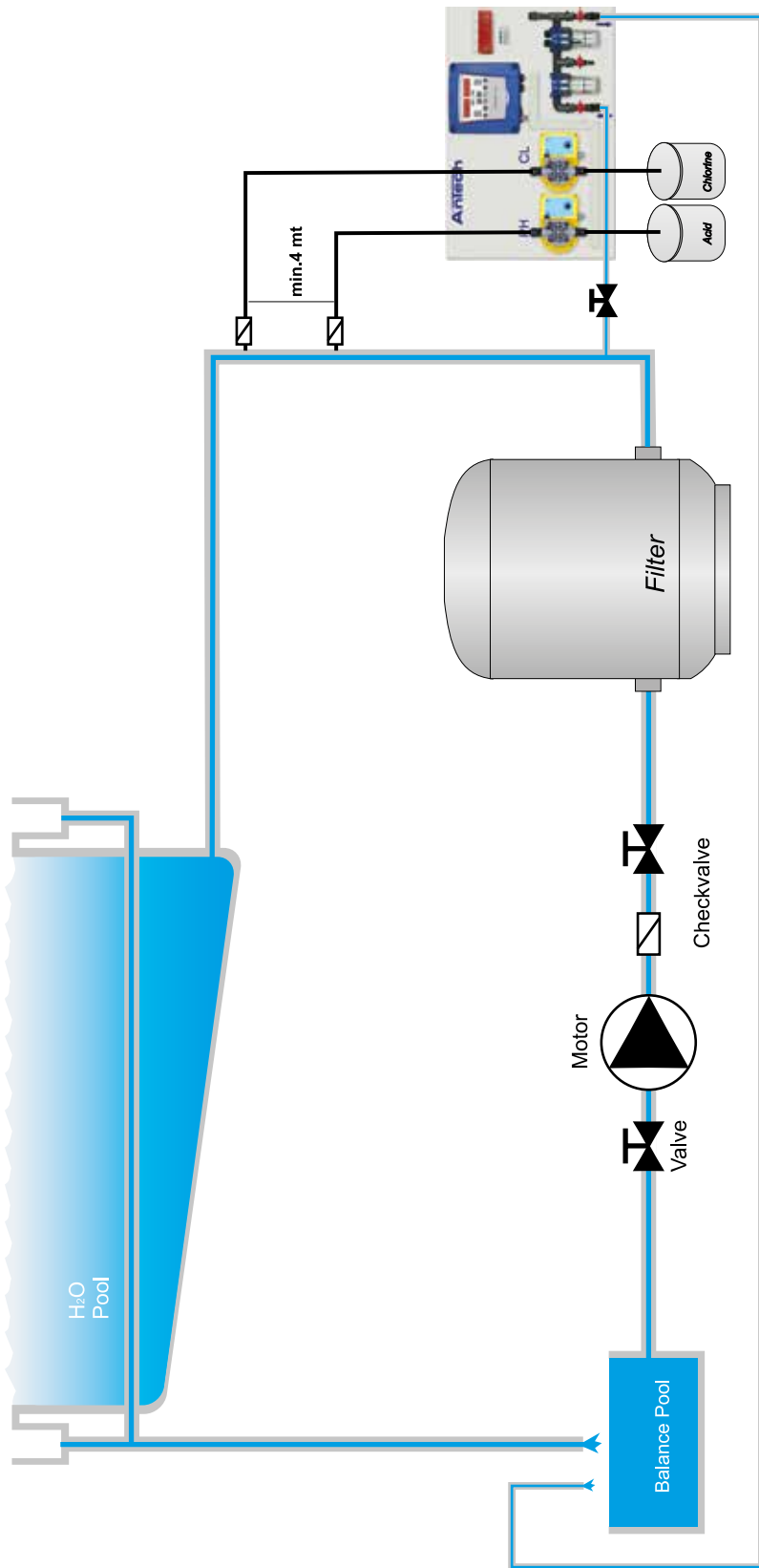

CHEMICAL RESISTANCE LIST

Chemical	Formula	Glass	PVDF	PP	PVC	SS316	PMMA	Hastelloy	PTFE	FPM	EPDM	NBR	PE	Norprene	Slicone
Acetic ACid. Max 75%	CH3COOH	2	1	1	1	1	3	1	1	3	1	3	1	3	1
Aluminium Sulphate	Al2(SO4)3	1	1	1	1	1	1	1	1	1	1	1	1	1	1
Amines	R-NH2	1	2	2	3	1	--	1	1	3	2	4	1	--	--
Calcium Hydroxide	Ca(OH)2	1	1	1	1	1	1	1	1	1	1	1	1	1	1
Calcium Hypochlorite	Ca(OCl)2	1	1	1	1	3	1	1	1	1	1	3	1	2	2
Copper sulphate	CuSO4	1	1	1	1	1	1	1	1	1	1	1	1	1	1
Ferric chloride	FeCl3	1	1	1	1	3	1	1	1	1	1	1	1	1	2
Hydrofluoric Acid 40%	HF	3	1	1	2	3	3	2	1	1	3	3	1	3	3
Hydrochloric Acid	HCl	1	1	1	1	3	1	1	1	1	3	3	1	2	2
Hydrogen Peroxide 30%	H2O2	1	1	1	1	1	3	1	1	1	2	3	1	2	1
Nitric Acid 65%	HNO3	1	1	2	3	2	3	1	1	1	3	3	2	3	3
Phosphoric Acid 50%	H2SO4	1	1	1	1	2	1	1	1	1	1	3	1	2	1
Potassium Permanganate 10%	KMnO3	1	1	1	1	1	1	1	1	1	1	3	1	--	--
Sodium Bisulphate	NaHSO3	1	1	1	1	2	1	1	1	1	1	1	1	1	1
Sodium Carbonate	Na2CO3	2	1	1	1	1	1	1	1	2	1	1	1	1	1
Sodium Hydroxide	NaOH	2	1	1	1	1	1	1	1	2	1	2	1	1	2
Sodium Hypochlorite %12.5	NaOCl+NaCl	1	1	2	1	3	1	1	1	1	1	2	1	1	2
Sulfuric Acid %85	H2SO4	1	1	1	1	2	3	1	1	1	3	3	1	3	3
Sulphuric Acid-93.5%	H2SO4	1	1	3	3	3	3	1	1	1	3	3	3	3	3

1 Resistant

2 Fairly Resistant

3 Not Resistant



